

Effect of Coiled Capillary Tube Pitch on Vapor Compression Refrigeration System Performance.

M.A. Akintunde, Ph.D.

Federal University of Technology, Department of Mechanical Engineering
PMB 704, Akure, Ondo State, Nigeria.

*E-mail: ajyinka@yahoo.com

ABSTRACT

The effects of various geometries of capillary tubes has been investigated by many researchers. Their studies were based on the coil diameters and lengths alone, with no particular attention placed on the effect of coil pitch. At present no information is available about the effects of serpentine coiled capillary tubes on refrigerator performance. This study examined the effects of pitches of both helical and serpentine coiled capillary tubes on the performance of a vapor compression refrigeration system. Several capillary tubes of equal lengths (2.03 m) and varying pitches, coiled diameters, and serpentine heights were used. Both inlet and outlet pressure and temperature of the test section (capillary tube) were measured and used to estimate the coefficient of performance (COP) of the system.

The results show that, in the case of helical coiled geometries the pitch has no significant effect on the system performance but the coil diameter as already predicted by many researchers. In the case of serpentine geometries both pitch and height affects the system performance. Performance increases with both increase in the pitch and the height.

Correlations were proposed to describe relationships between straight and coiled capillary tube and between helical coiled and serpentine coiled capillary tubes. The coefficient of correlations are: 0.9841 for mass flow rates of helical and serpentine with straight tubes; 0.9864 for corresponding COPs and 0.9996 for mass flow rates of serpentine and helical coiled tube.

(Keywords: capillary tube, geometry, helical coil, serpentine coil, COP, correlations, refrigeration)

INTRODUCTION

In small refrigeration and air conditioning systems one of the commonly used expansion devices to control the flow rate of refrigerants is the capillary tube. This is a simple tube of a few millimeters internal diameter, usually ranging between 0.5 to 2 mm (Stoecker and Jones 1982). Although the device lacks active function (mechanical or electrical) to actively adjust to any sudden change in the load conditions, it is still in use as a result of its simplicity, low cost, and requirement of low compressor starting torque (Kim *et al.* 2002).

The required length of capillary tube depends mostly on the size of the system. The required length has reported by Wei *et al.* (2001) for small refrigeration systems, ranges from 400 to 2500 mm. If this length is to be kept straight in any application (that is installation), a lot of space would be required. As a result, the capillary tubes are normally folded in various configurations, so as to reduce the required space.

There are extensive data for adiabatic capillary tubes and reliable diagrams. Some of these can be found in the works of Bittle *et al.* (1998), ASHRAE (1994), Akintunde (2004a) and Kim *et al.* (2002).

Since the capillary tube is to be folded in order to reduce the required space, there is the need to study the effect of capillary tube geometry on the performance of refrigeration systems. Wei *et al.* (2001) studied the performance of capillary tubes for R-407C refrigerant. In their study a total of nine capillary tubes were tested. The capillary tubes consisted of straight and coiled configurations. Their result was compared with the correlations proposed by Bittle *et al.* (1998) and ASHRAE (1994).

The geometry of the capillary tubes used by Wei *et al.* (2001) are: length (1000 mm), internal diameter (1.0 mm) and two coiled diameters of 52 and 130 mm. Comparing the flow rate of the coiled configuration with that of straight capillary tube, for the same inlet and outlet pressures, tube diameter and length, the mass flow rate decreases with decrease in coiled diameter. The *decrease ratio* which was evaluated as $m_{coil}/m_{straight}$ is relatively insensitive to change of inlet sub-cooling and inlet pressure for both R-22 and R-407C considered.

Akintunde (2004b) reported the performance of R-12 and R-134a in capillary tubes for refrigeration systems. In his work, fifty-eight (58) capillary tubes of different geometries (50 straights and 8 coiled) made of copper-tubes were used. The straight tubes were of ten different lengths (ranges from 1.53 to 2.63 m) and five different internal diameters (ranges from 0.72 to 1.62 mm), while the coiled were of two straight lengths (1.53 and 2.03 m) with four different coiled diameters (50, 100, 150 and 200 mm) but of the same internal diameter of 1.62 mm. It was shown in his results that a capillary tube of length 2.03 m with tube diameter not less than 1.1 mm and coiled diameter of at least 1000 mm could be used for small refrigeration systems of capacities ranging between 8 to 12 kW. His results also indicated that mass flow rate decreases with coil diameter.

The decrease of mass flow rate with coil diameter is a general trend and this can be justified from the works of Motta *et al.* (2002); Domanski (1994); Kim *et al.* (1998); and Akintunde (2003, 2004a). These works were focused on the length and coiled diameters of the capillary tubes only but none of them talk about the pitch of the coils. Also all the available data are for helical coiled geometries; there is none for serpentine geometries. Therefore, the objectives of the present work is to: investigate the effect of pitch of both helical and serpentine coiled capillary tubes on the performance of vapor compression refrigeration systems; and compare the effects of helical coiled with those of serpentine coiled, using R-134a as the working refrigerant as suggested by Akintunde *et al.* (2006).

MATERIALS AND METHODS

A schematic diagram of the experimental apparatus is shown in Figure 1. The apparatus consists of a vapor compression refrigeration

cycle adapted to accommodate instruments and controls that allow for the study of expansion devices. Manual service valves allowed the isolation of the expansion device to be tested so that minimal refrigerant will not be lost when the test section is changed. It also allowed the control of mass flow rate so that critical flow condition would be maintained in the evaporator.

Pressure and temperature were measured both upstream and downstream of the test section. Type T thermocouples calibrated within the range of -20°C to 100°C were attached to the external surface of the tube (before and after the test section). Pressure transducers model R50a from "Yellow Jacket", capable of measuring pressure between 0 and 2000 kPa with mean uncertainty of ± 10 Pa, were also installed down and upstreams of the test section.

A refrigerant flow meter, model R70a, manufactured by "Yellow Jacket", calibrated to a mean uncertainty of $\pm 0.20\%$ was used to measure the flow rate. These instruments were tested using a straight capillary tube of length 2.03 m, as predicted by Jung *et al.* (1999), Akintunde (2004b) and Akintunde *et al.* (2006) for a vapor compression refrigeration system of 10 kW capacity, operating under the conditions of 40°C condensing temperature, 1.62 mm capillary inside diameter and evaporator temperature of -5°C . The average flow rate was found to be 0.0105 kg/s, which is about 5% above the predicted value of 0.01 kg/s.

Table 1 shows the geometry of the test section used with all dimensions in (mm); d = coil diameter; p = pitch. Figure 2 provides the illustrations.

All measurements were carried out at steady-state conditions. According to Lee *et al.* (2002), Motta *et al.* (2002), and Akintunde (2004b) from system start-up, 120 minutes were typically required for the capacity used in this investigation to establish steady-state condition and approximately 90 minutes elapsed between each measured point (operating condition).

The purpose of installing a heater (adjustable) is to ensure critical flow in the test section so as to maintain a constant pressure in the evaporator. This will serve as control for the experimental procedure.

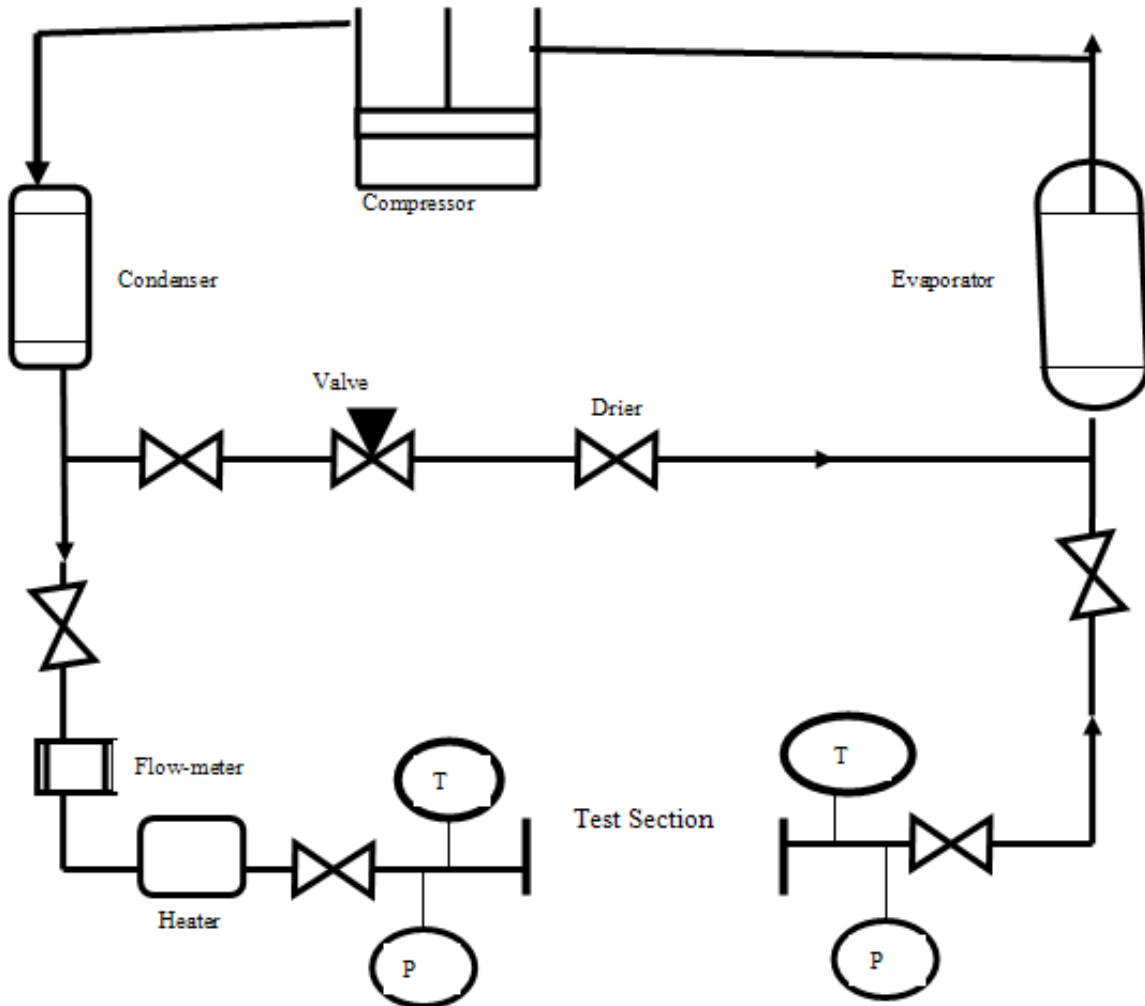
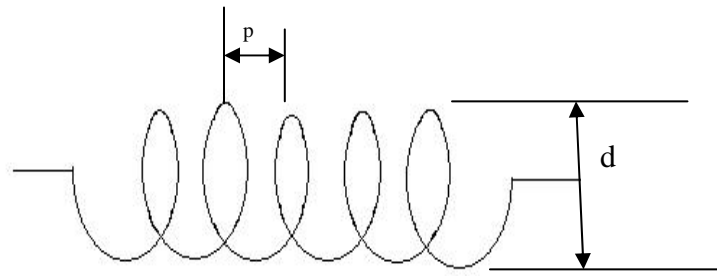

Figure 1: Schematic Diagram of Experimental Set-up.

Table 1: Geometries of Test Sections.

d1 = 80			d2 = 100			d3 = 120			d4 = 160			d5 = 200			Helical coiled
P1	P2	P3	P1	P2	P3	P1	P2	P3	P1	P2	P3	P1	P2	P3	
4	6	10	6	8	10	6	8	10	6	8	10	6	8	10	
H1 = 80			h2 = 100			H3 = 120			h4 = 160			h5 = 200			Serpentine coiled



(a) Helical Coiled Capillary Tube.

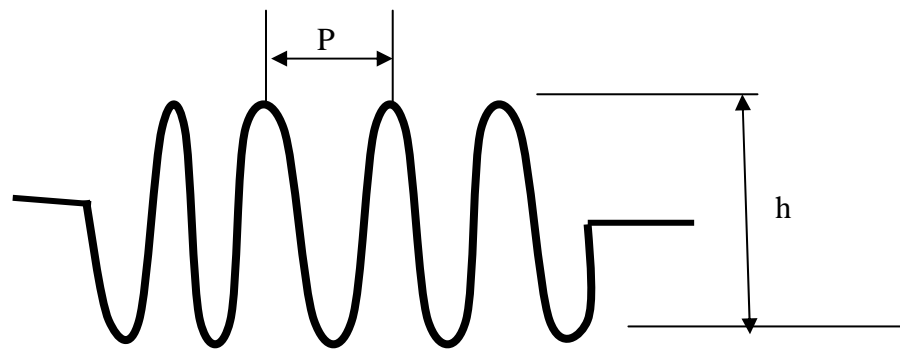

(b) Serpentine Coiled Capillary Tube.

Figure 2: Illustrations of the Test Sections.

It has been reported that the degree of sub-cooling enhances the COP Akintunde *et al.* (2006); hence the degree of sub-cooling was kept constant at 5°C throughout the investigation.

RESULTS AND DISCUSSION

The measured flow rate (using straight capillary tube) in this investigation falls within the results of Jung *et al.* (1999), Kim *et al.* (2002), and Akintunde (2004a), this is a justification of the experimental procedure. The measured parameters – pressure (P) and temperature (T) were used to estimate the coefficient of performance (COP) which is the reflection of the capillary tube configurations.

Figure 3 shows the variation of mass flow rate with pitch at different helical coil diameters; while Figure 4 shows corresponding variations of COP. Figures 5 and 6 are the corresponding figures for mass flow rate and COP for serpentine coiled capillary tubes. Variation of average COPs, for both helical and serpentine coiled, with d and h respectively are shown in Figure 7.

As can be seen in Figures 3 and 4, there is no significant increase in both mass flow rate (\dot{m}) and COP with increase in pitch. As the coiled diameter (d) increases there is a significant increase in both \dot{m} and COP. These show that, for helical coiled capillary tubes, the effect of pitch on system performance is not pronounced.

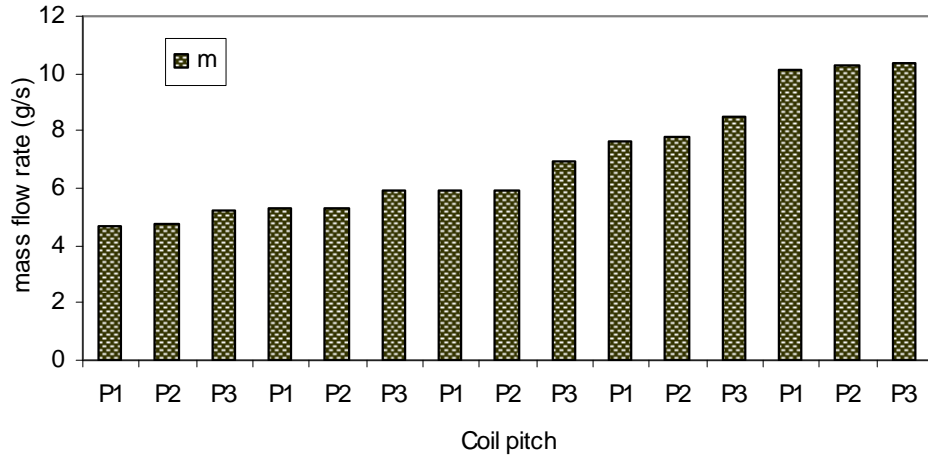

Figure 3: Variation of Mass Flow Rate with Coil Pitch.

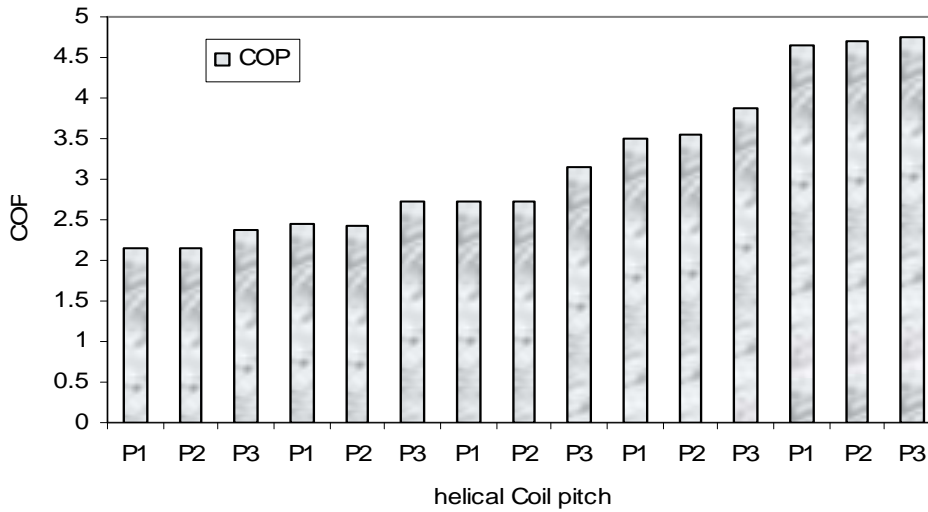

Figure 4: Variation of COP with Coil Pitch.

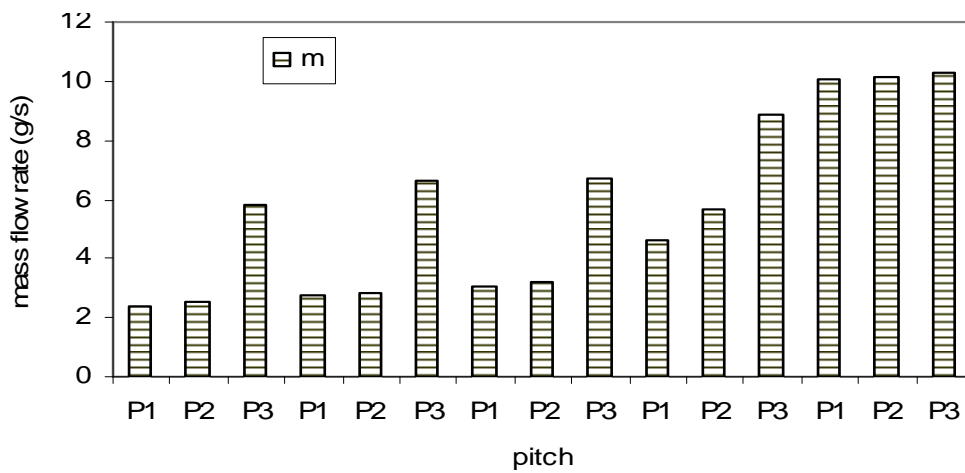

Figure 5: Variation of Mass Flow Rate with Serpentine Pitch.

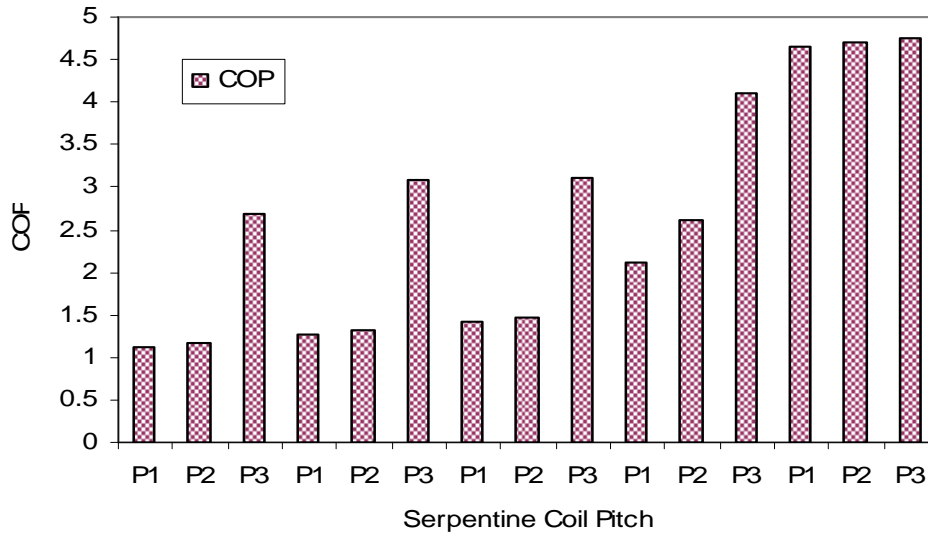

Figure 6: Variation of COP with Serpentine Pitch.

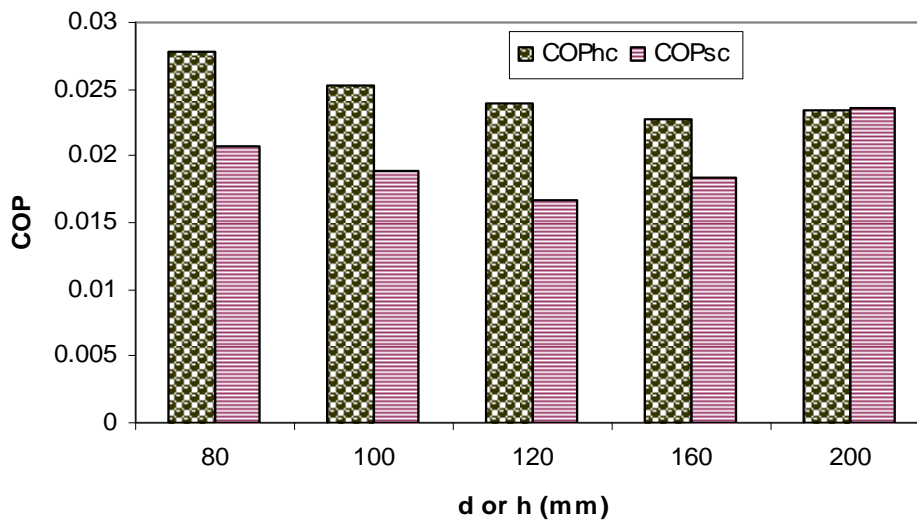

Figure 7: Variation of average COP of the Coils with d and h.

In Figures 5 and 6 both mass flow rate (\dot{m}) and COP increases with both h and d . These show that the serpentine pitch has effects on the performance of the system. Since the performance is not significantly affected by pitch in the case of helical coiled, less space will be required for its installation, while in the case of serpentine coiled more space would be required. It can be said here that helical coiled can be used for small systems why serpentine coiled that required lot of space may not be suitable for large units.

A correlation of mass flow rates of both helical and serpentine coiled with straight capillary tube under the same conditions is shown in Figure 8. A model was then developed between the mass ratio and both h and d .

The model equation is given in Equations (1) and (2) for both helical and serpentine coiled capillary tubes respectively.

$$M_{cr} = (2.9d^2 + 4.7d + 48) \times 10^{-2} \quad (1)$$

$$M_{sr} = (5.7h^2 + 19.6h + 50.2) \times 10^{-2} \quad (2)$$

As shown in Fig. 8 correlations are 0.9973 and 0.9841 respectively for both helical and serpentine coiled tubes.

Two corresponding model for mass ratios of serpentine to helical coil with either h or d is shown in Equation (3). The correlation coefficient is 0.9996, this is justified by Figure 9.

$$\left. \begin{aligned} M_r &= (2h^2 - 170h + 1090) \times 10^{-5} \\ or \\ M_r &= (2d^2 - 170h + 1090) \times 10^{-5} \end{aligned} \right\} \quad (3)$$

The corresponding model for COP ratios, with a coefficient of correlation of 0.9864 is shown in Equation (4) and Fig. 10.

$$\left. \begin{aligned} COP_r &= 0.0024 \ell^{-0.066d} \\ or \\ COP_r &= (0.0024 \ell^{-0.066h}) \end{aligned} \right\} \quad (4)$$

Furthermore, Figures 8 through 10 show that helical coiled is more reliable than serpentine coiled in small systems.

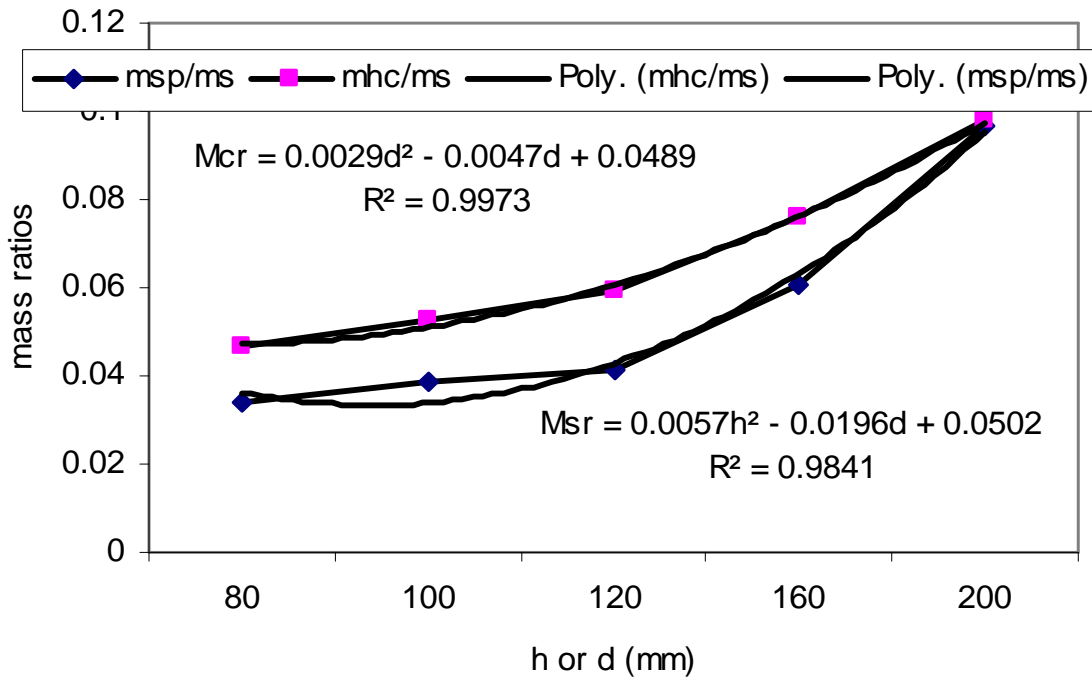

Figure 8: Variation of Mass Ratios with h/d.

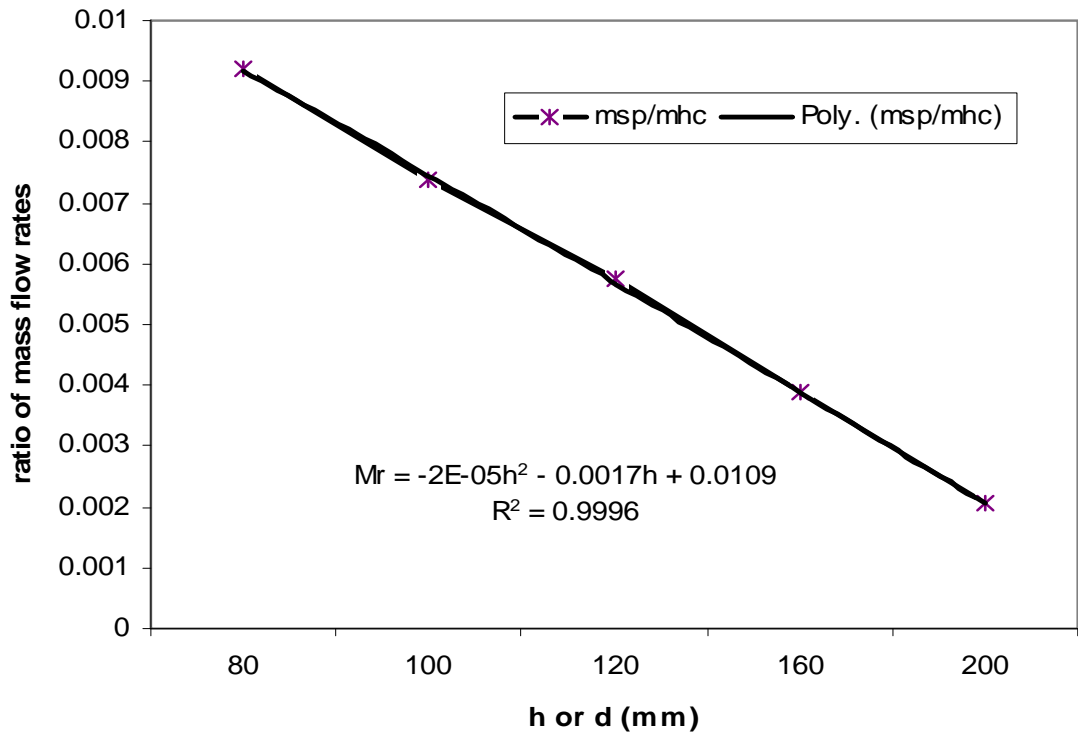

Figure 9: Variation of Mass Flow Rate Ratios.

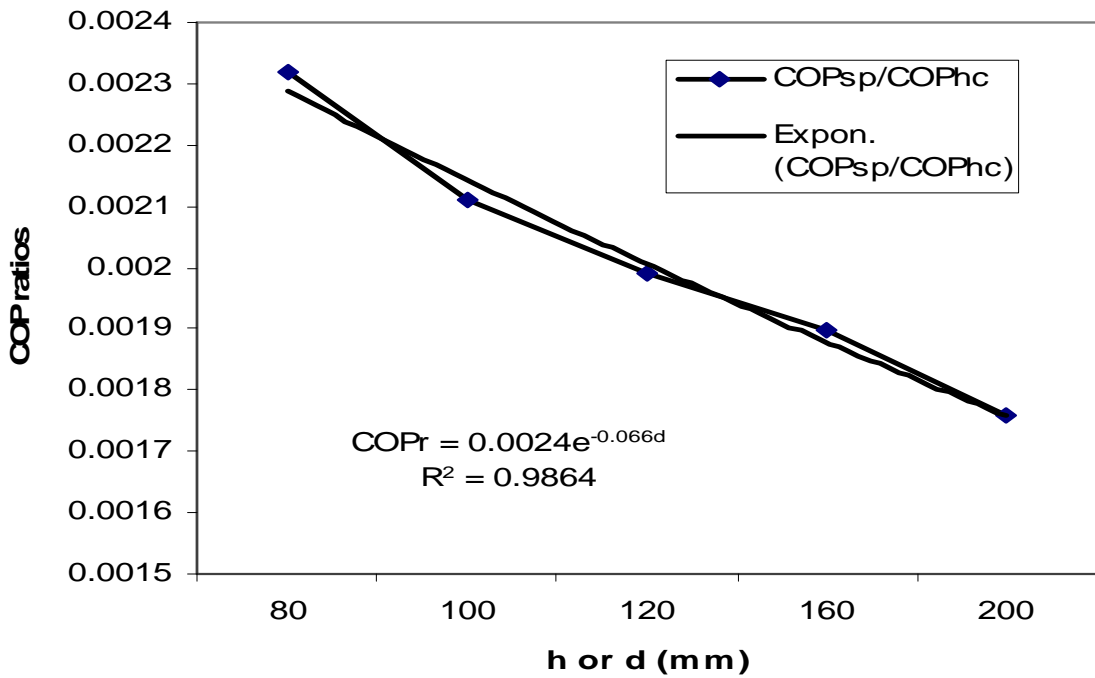

Figure 10: Variation of COP Ratios.

CONCLUSION

This study investigated the performance of capillary tube geometries having R-134a as the working fluid. Two specific geometries were examined, these are helical and serpentine. The test results of the helical coiled agreed well with the results of Wei *et al.* (2001) and Akintunde *et al.* (2006). The obtained results show that, pitch variation has no significant effect on the system performance but the coiled diameter in the case of helical coiled. While, in the case of serpentine coiled both the height (h) and the pitch affects the performance. As both height and the pitch increases the performance increases. This indicated that more space will be required for the installation and hence this configuration will not be suitable for small systems.

Correlations were proposed to evaluate the correlations between straight and coiled capillary tubes and between helical coiled and serpentine coiled capillary tubes.

NOMENCLATURE

d = helical coiled diameter (mm)
h = serpentine height (mm)
p = pitch (mm)
COP = coefficient of performance
m = mass flow rate (g/s)
msp = mass flow rate for serpentine coiled (g/s)
mhc = mass flow rate for helical coiled (g/s)
ms = mass flow rate for straight tube (g/s)
R = correlation coefficient

$$Mcr = \frac{m_{hc}}{m_s}$$

$$Msp = \frac{m_{sp}}{m_s}$$

$$COPr = \frac{COP_{serpentine}}{COP_{helical}}$$

ACKNOWLEDGEMENT

The author hereby acknowledge the Federal University of Technology, Akure for providing the grant for this research. The grant reference number is URGC/MINOR/2007/183. Thank you.

REFERENCES

1. Akintunde, M.A. 2003. "Development of a Vapour Compression Refrigeration Systems Model Based on Balanced Points Between the Operational Units". Ph.D. Thesis in the Department of Mechanical Engineering, Federal University of Technology, Akure, Nigeria.
2. Akintunde, M.A. 2004a. "Theoretical Design Model for Vapour Compression Refrigeration Systems". *ASME J.* 73(5):1-14.
3. Akintunde, M.A. 2004b. "Experimental Investigation of the Performance of R-12 and R-134a in Capillary Tubes for Refrigeration Systems". *Nigerian J. Tech. Devel.* 4:1-12.
4. Akintunde, M.A., Adegoke, C.O., and Papetu, O.P. 2006. "Experimental Investigation of the Performance of a Design Model for Vapour Compression Refrigeration Systems". *West Indian Journal of Engineering.* 28(2):80 – 87.
5. ASHRAE. 1994. *ASHRAE Handbook Refrigeration.* Chapter 44. American. Society for Heating, Refrigeration, and Air-Conditioning Engineering: Atlanta., GA.
6. Bittle, R.R., Wolf, D.A., and Pate, M.B. 1998. "A Generalized Performance Prediction Method for Adiabatic Capillary Tubes". *HVAC & R Res.* 14:27-43.
7. Domanski, P.A., Didion, D.A., and Doyle, J.P. 1994. "Evaluation of Suction Line - Liquid Line Heat Exchanger in the Refrigeration Cycle". *Int. J. Refrig.* 17:487-93.
8. Jung, D., Park, C., and Park, B. 1999. "Capillary Tube Selection for HCFC-22 Alternatives". *Int. J. Refrig.* 22:604-14.
9. Kim, Y.H., Kim, C.N., and Park, Y.M. 1998. "Investigation on the Selection of Capillary Tube for the Alternative Refrigerant R-407C". *J. Air-Cond. Refrig. Engin.* 10:56-65.
10. Kim, S.G., Kim, M.S., and Ro, S.T. 2002. "Experimental Investigation of the Performance of R-22, R-407c and R-410a in Several Capillary Tubes for Air-Conditioners". *Int. J. Refrig.* 25: 521-31.
11. Lee, J.H., Bae, S.W., Bang, K.H., and Kim, M.H. 2002. "Experimental and Numerical Research on Condenser Performance for R-22 and R-407C Refrigerants". *Int. J. Refrig.* 25:372-82.
12. Motta, S.F.Y., Parise, J.A.R., and Braga, S.L. 2002. "A Visual Study of R-404a/Oil Flow Through Adiabatic Capillary Tubes". *Int. J. Refrig.* 25:586-97.

13. Stoecker, W.F. and Jones, J.W. 1982.
Refrigeration and Air Conditioning. 2nd ed.
McGraw-Hill: Bogota. Colombia.
14. Wei, C.Z., Lin, Y.T., Wang, C.C., and Lev, J.S.
2001. "An Experimental Study of the Performance
of Capillary Tubes for R-407c Refrigerant."
ASHRAE Trans. 27:634-8.

ABOUT THE AUTHOR

Dr. M.A. Akintunde, graduated from Obafemi Awolowo University, Ile-Ife in 1992 with first class honors in the Department of Mechanical Engineering. He studied Building Services Engineering at The Federal University of Technology, Akure (Nigeria). He completed his Master's degree in 1997 and Ph.D. in 2004. He is a Senior Lecturer in Mechanical Engineering at the Federal University of Technology, Akure Nigeria. His research interest includes refrigeration and air-conditioning, energy systems, thermodynamics, and mechanics.

SUGGESTED CITATION

Akintunde, M.A. 2008. "Effect of Coiled Capillary Tube Pitch on Vapor Compression Refrigeration System Performance". *Pacific Journal of Science and Technology*. 9(2):284-293.

