

# First Dual-Sensor Ocean Bottom Cable 3D Seismic Acquisition South Atlantic Ocean, Offshore Niger Delta, Nigeria

C.C. Ugbor, M.Sc.

Department of Geology, University of Nigeria, Nsukka, 410001, Enugu State, Nigeria.

E-mail: [charlescugbor@yahoo.co.uk](mailto:charlescugbor@yahoo.co.uk)

## ABSTRACT

This paper describes the ocean bottom cable (OBC) technology and its application to the Niger Delta. The OBC technology essentially operates on the multi-sensor cables deployed on the ocean floor, which records both the velocity and pressure signals, among others. The cables are adapted to acquiring seismic data using any of the seismic acquisition geometries. The ocean bottom cable seismic acquisition in the Niger Delta employed the cross spread geometry in "swath" assignments. Strapped to the cable at regular intervals are multi-component (4c) receivers or dual sensor (2c) receivers which detect seismic signals reflected from the subsurface formations. These signals are digitized in remote electronic modules along the cables and telemetered via the cables to a recording vessel. The location determination is established using the (Differential) Global Positioning System. From the result of the OBC offshore concession in the study area, the dual-sensor summation has proved its effectiveness in providing broadband, high resolution reflection data without the potential contamination of water-column reverberations or ambient noise. This is evident in the high quality of the preliminary 3D cube slices generated. The high quality of the preliminary 3D cube time slice imaging is encouraging. The OBC dual-sensor technology is certainly an innovative technology for future seismics.

(Keywords: seismic acquisition, ocean bottom cable, OBC, multi-sensor, subsurface formations, petroleum exploration)

## INTRODUCTION

Earlier authors have variously discussed the Ocean Bottom Cable seismics (example, Barr,

1995; Barr *et al.*, 1989; Beasley *et al.*, 1997; Cafarelli, 1995; and Gaiser and Neil, 1996).

This research is intended to present an overview of a standard Ocean Bottom Cable (OBC) seismics through a practical on-board experience. Here, the concepts of multi-sensor (4C) and dual sensor data types are introduced. Also discussed are the data acquisition, and processing techniques namely, the dual sensor summation. Similarly, the virtually unlimited advantages of the OBC seismics over the conventional marine streamer systems are also highlighted. Also discussed is the dual sensor OBC's uniqueness in the execution of the newer time-variant (4D) seismics – a prerequisite for better reservoir monitoring and evaluation, an evolving trend in the innovative seismic technology for future.

The OBC method has the advantage of obtaining coverage in congested producing fields clustered with platforms, pipelines, and drilling rigs, where towed source vessel operations are difficult or impossible. It is also suited to shallow water, lakes, bays and rivers. It offers a range of benefits including higher signal bandwidth, high spatial resolution, low noise, minimum down-time, design flexibility, improved near surface solution, full coverage in obstructed areas, and virtually unlimited offsets. Its future include reservoir monitoring – concept of 4D (time-lapse) seismics.

The OBC 3D dual sensor concession in the South Atlantic ocean under study has been the first OBC acquisition offshore Niger Delta, Nigeria. The method has hitherto been applied in the Gulf of Mexico and the North Sea. This paper is based on the author's experience, having joined the Party 66 of the Western Geophysical's Atlantic Explorer Crew during the concession in 1999. The discussion includes the geometry used, the seismic source and the

receiver used, the positioning systems, and the recording equipment in addition to the preliminary onboard processing results—particularly the 3D time slice from the cube plots.

### BASIC IDEAS OF THE OCEAN BOTTOM CABLE SEISMICS

The OBC is a special type of marine seismic acquisition which involves the laying of the receiver lines on the ocean floor, the multi-component sensors of the receivers being composed of a coupling of a hydrophone and three geophones (Cafarelli, 1995). Figure 1 shows a typical ocean bottom cable on the seafloor.

A typical ocean bottom cable crew comprises four to six vessels, with minimum configuration being a source boat, a recording boat, and at least one cable boat. Cables are normally squirted from the back deck of the cable boat by an operator controlled hydraulic device while the vessel traverses the pre-planned line.

Many crews have at least two cable boats and one chase (utility) boat. During an OBC

operation, the recording boat may be anchored along the line or dynamically positioned. In contrast to the conventional towed streamer operations, the source boat tows only the airgun array, allowing it to manoeuvre very close to obstructions as well. A chase boat facilitates movement of people and equipment from vessels and to and from the shore. It also performs picket duty, warning encroaching vessels of the cables below.

OBC crews typically operate in water depths up to 100m, the low end being determined by vessel draught rather than equipment. However, most equipment can operate at 200m, which appears to be the limit of the foreseeable future. A major feature of the OBC operation is onboard recording and processing. Jumpers connect the OBCs to the stationary recording vessel at its “set up” location. The next set of the cables – the next “patch or swath” – can be powered up, tested and located before recording has finished on the current set of cables. This reduces time spent moving from one recorder set up to the next.

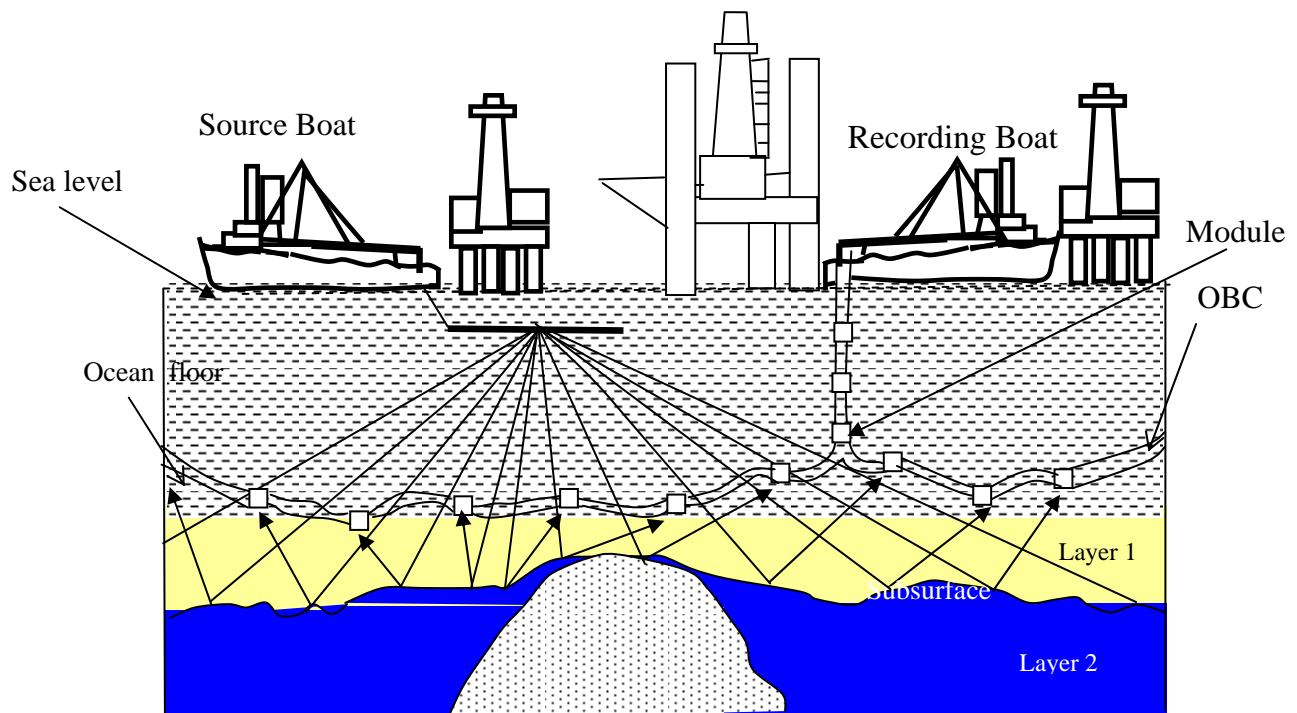

**Figure1:** A Typical Ocean Bottom Cable Operation with Vessel afloat and receiving lines on the Ocean Floor.

A remote positioning system is met by the use of the Global Positioning System (GPS) in ocean bottom cable seismic operations. The GPS is a satellite based positioning system which computes the user's position and velocity in three dimensions using passive ranging. The energy source is located using either absolute positioning methods or acoustically coupled method, while the receiver location is obtained using first break or acoustic methods.

Dual sensor OBC seismics involves the use of detectors that respond to pressure waves (hydrophones) and vertical or crossline component of the water-bottom motion (vertical or crossline geophone). The multi-component OBC involves the use of 4 or more receivers instead. Here, additional measurement is made of the shear-waves and the converted (PS-waves). This includes horizontal geophones (in-line geophones) which respond to PS-waves. An important advantage of recording S-waves is their insensitivity to the type of fluid in sediments. Shear waves see through gas chimneys that plague economically important areas such as the North Sea. These destroy P-wave continuity but hardly affect S-wave reflections. Shear waves also help explorationists discriminate among lithologies (sand and shales) and are important in fracture detection (Gaiser *et al.*, 1996 and Western Atlas, 1998).

Dual sensor recording uses co-located hydrophones and geophones consequently, when traces from these are suitably combined, the receiver ghost trends to cancel, and the reverberation problem is attenuated. It can be seen that the two spectra are complementary – where there are notches in one there are peaks in the other. Hence frequencies missing from the notch in the hydrophone spectrum are supplied by a peak in the geophone spectrum. Summing the two signals removes the spectral notches yielding a much more desirable spectrum (Figure 2).

An additional benefit is wavelet stability. After removing the harmful effects of the receiver ghost, a stable wavelet remains, which is independent of water depth and provides for much more detailed stratigraphic analysis. A chief dual-sensor benefit is the improved frequency range, or bandwidth, achieved over other methods. Increasing bandwidth allows resolution of thinner beds. Marine streamers record a receiver ghost, which affects the higher frequency parts of the spectrum, reducing bandwidth. Since the receivers are located on the water bottom, potentially all the water layer reverberations may be eliminated with the ancillary benefit of extracting the relative water bottom reflectivity. Having eliminated the ghost, the dual-sensor data can be richer in higher frequencies. The geophone contribution usually improves low-frequency content as well.

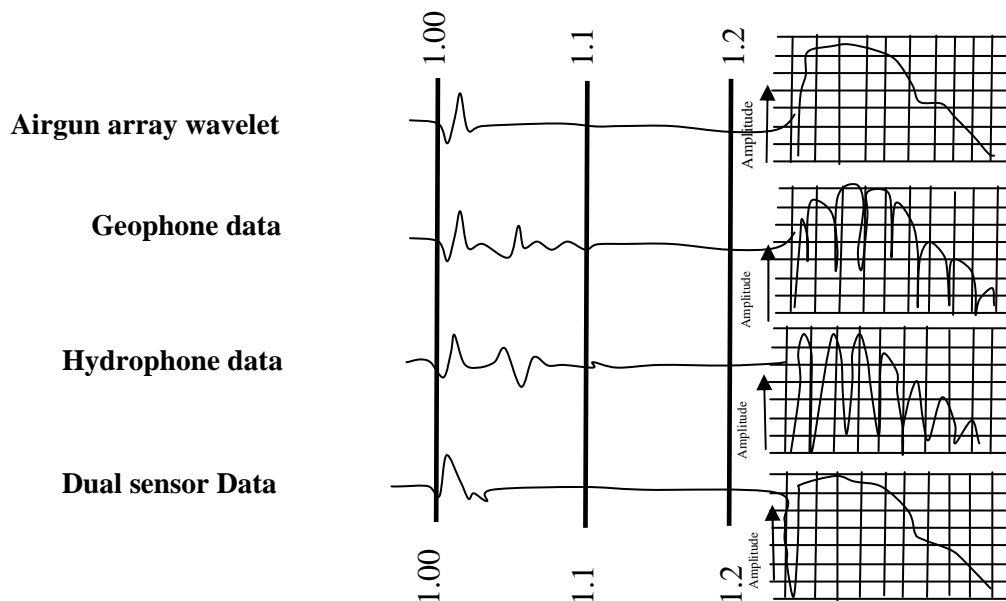

**Figure 2:** The Combination of both Bottom-Cable Geophone and Hydrophone Signals (dual sensor summation) to Eliminate Water Column Reverberation.

## DUAL-SENSOR 3D OBC SEISMIC SURVEY IN THE SOUTH ATLANTIC OCEAN, OFFSHORE NIGER DELTA, NIGERIA

In late 1998 (December 28<sup>th</sup>) and during the first half of 1999, a 665 km<sup>2</sup> dual-sensor 3D OBC survey was conducted in the Niger Delta, offshore Nigeria (Ugbor, 1999). The water depth ranged from 4 to 20m. The area is active with both fishing and transit vessel activities with a vessel channel running approximately through the Northeast-Southwest length of the area. Dredging activity was also going on at the north-western part of the area. Because the survey objective could not tolerate shallow zones of missing data inherent in multi-beat, towed streamer acquisition operations, the bottom-cable data collection method was chosen.

The bottom-cable method allowed shots and receivers to be placed very close. The geometry used was that of a land 3D cross array patch, yielding uniform coverage and eliminating the need for infill shooting. The prospect area was divided into several rectangular portions called swaths along which a recording template was rolled in a cross array patch (Cross Spread) geometry. The method also provided for true surface consistent refraction and reflection statics calculation and high subsurface imaging.

### a) Location and Extent of Survey Area.

Figure 3 shows the location of the survey area, in the world map showing the Atlantic ocean and offshore Niger Delta, Nigeria. The water depth ranges from 4m at the North (closest to the shore) and 20m towards the South of the prospect area. There is a dredged shipping channel through the survey area to the coast trending approximately NE-SW. There are numerous obstructions in the survey area, related to the oilfield activity, commercial activity, and fishing.

## OPERATING VESSELS

Several vessels were employed by the Western's Party 66 in the OBC acquisition in the offshore Niger Delta. Often more than one vessel was employed to carry out one task. The main vessels include the recording vessel – M/V C-Commodore, cable vessels – M/C C-Centurion and M/V C-Cadet, and the shooting vessels –



**Figure 3:** Location of the OBC Survey Area (cross-hatched) in Offshore Niger Delta, Nigeria, in the map of Southern Nigeria with part of the South Atlantic Ocean.

M/V Western Anchorage and M/V Western Tucano. The M/V Tucano and M/V Western Equator are drought vessels employed at the shallower water ends such as at depth below 6m. Other ancillary vessels used during the survey include the supply boat – the Sea Corp, and other chase/utility boats used for crew changes or equipment transfers. The various vessels used during the survey are shown in Figure 4.

## SURVEY DESIGN AND ACQUISITION PLAN

The survey design for the two phases differ slightly due to some operational peculiarities but each design was aimed at achieving the set objective of superior subsurface imaging of the target zone and bin size of 52.

### OBC ACQUISITION PLAN FOR PHASE 1:

The basic acquisition geometry was a 4-receiver line, asymmetric split spread patch with 2 orthogonal source lines 8 times the receiver line spacing in length. Each source line contributes to attenuate in-line direction ran parallel to the coast.

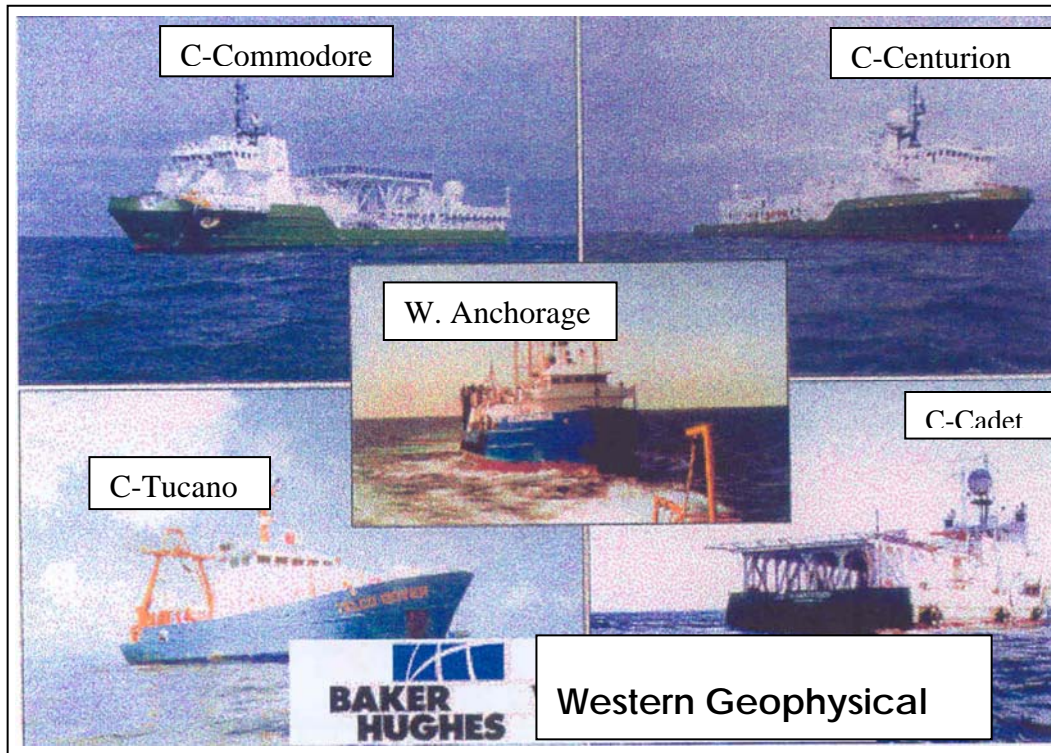

**Figure 4:** Some of the Vessels used During the OBC Survey.

This patch is rolled 300m in-line and 24m crossline. The patch asymmetry is inverted halfway long the swath, (the direction along which the patch template is rolled). By keeping the active swath fixed while the source pattern was continued to roll, the reversal is achieved and then the patch as a whole rolls until the end of the swath.

#### TYPICAL PROSPECT PARAMETERS

Full fold area: 364.7 km<sup>2</sup>  
 Number of Swaths = 12.

The survey geometry parameters, Cross-line Swath Asymmetric Split spread used in the prospect are shown in Tables 1 and 2.

Three source-line sets, one source-line per receiver pattern roll, alternating on the 1/2, 1/6 and 5/6-station position. Each shot contributes to 2 out of every 3 cells in the in-line direction. It should be noted that there was no limb inversion

in Swath 12. The swath arrangement is shown in Figure 5.

**Table 1:** Phase 1. Survey Geometry: Cross-line Swath Asymmetric split spread

|                              |  |
|------------------------------|--|
| <b>Cell Size</b>             | 18.75m x 12.5m. Nominal fold 61.7(52 specification)                                |
| <b>No. of Receiver Lines</b> | 4: Receiver line Azimuth. 180°   |
| <b>Receiver Line Spacing</b> | 600m: No. of active Groups/line 139  |
| <b>Group Interval</b>        | 56.25m: Active split-spread 7818.75m (2109.375/5709)                               |
| <b>Shotline Interval</b>     | 25m: Shotline length 4800m   |
| <b>Shotline Spacing</b>      | 168.75m: (nominal) Shotline stragger (in-line), (-18.75 m + 18.75m , alternating). |

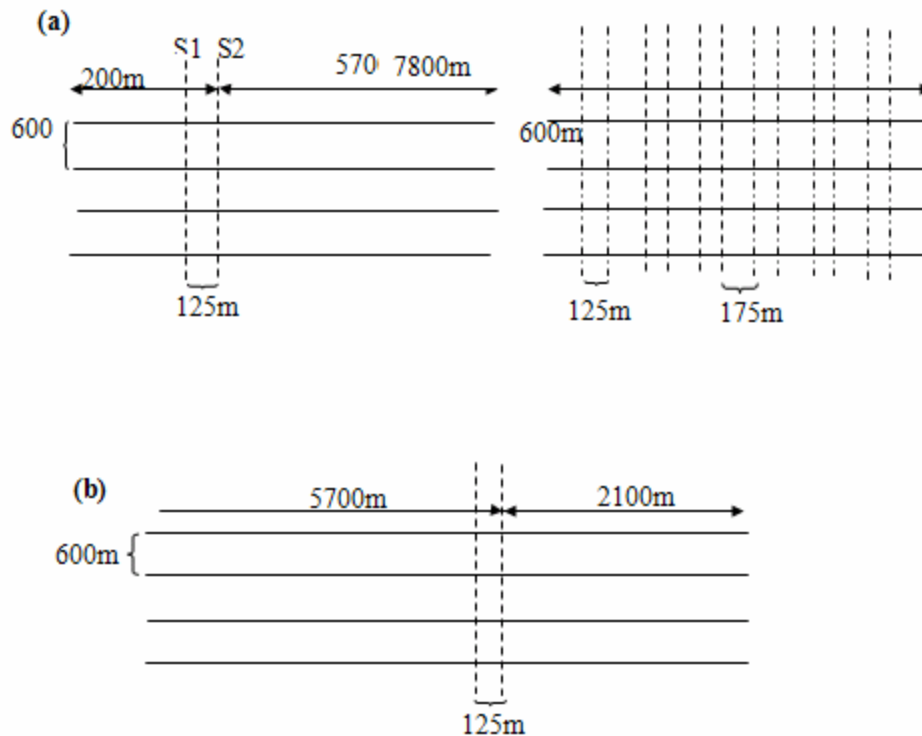

**Figure 5:** a) West Recording Patch Template (b) East Recording Patch Template.

**Table 2:** The Phase 2 Prospect Survey Parameters.

| # of Swath | Total Shotline Source-Lines | Length (m) | # of Groups | Total Receiver Cables | Line length (m) |
|------------|-----------------------------|------------|-------------|-----------------------|-----------------|
| 1-10       | 116                         | 556,800    | 4 x 298     | 100                   | 16,875          |
| 11         | 116                         | 455,400    | 4 x 298     | 100                   | 16,875          |
| 12         | 47                          | 225,600    | 4 x 160     | 54                    | 9,112.5         |

### BOTTOM CABLE OPERATIONS

In the 3D OBC Seismic recording, several, about 7800m cable long were deployed on the water bottom so that receiver groups lay within pre-planned bins. During an OBC seismic data acquisition, the cable vessel lays the cable on the sea floor by squirting the cable from the back of the vessels as the vessel passes through the predetermined traverse/swath arrangement. Figure 6 shows the Cable vessel operation in the Atlantic Ocean, offshore Niger Delta with one of the seismic crew members and the author onboard, monitoring the progress from the deck of the Recording Vessel.

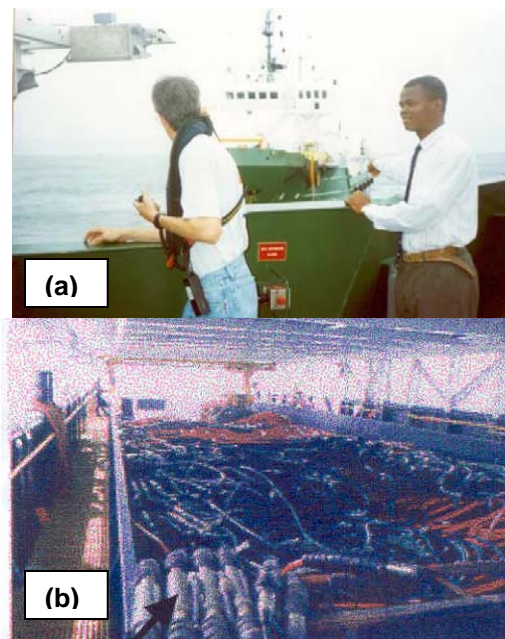
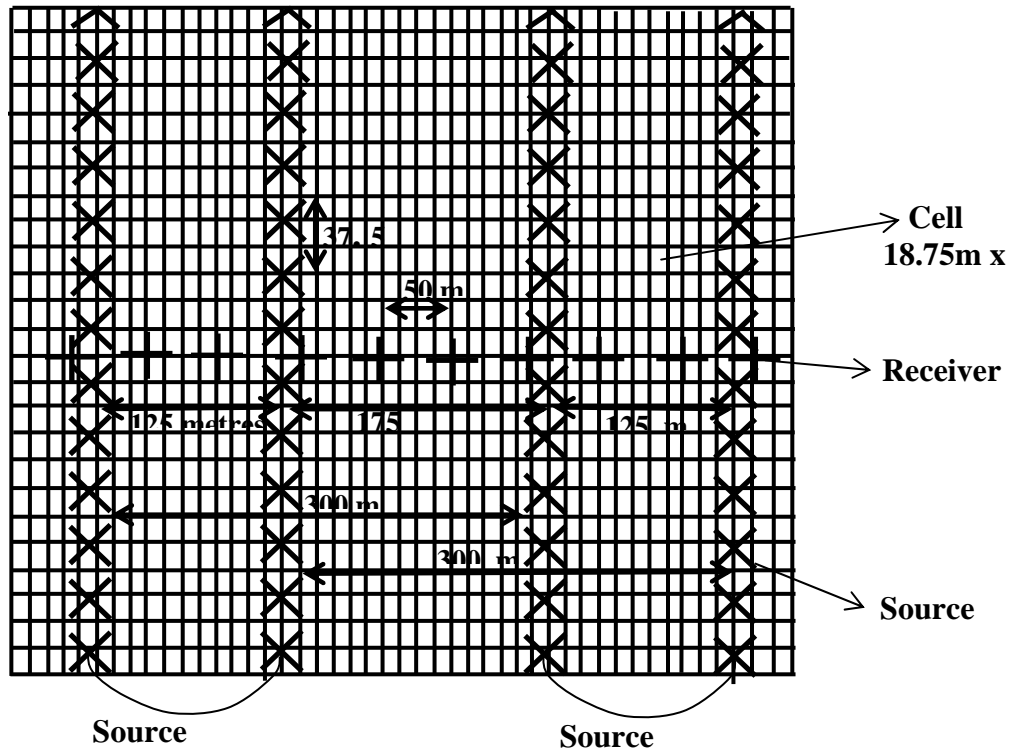

**Figure 6:** (a) Cable Vessel operation in the Atlantic Ocean - laying cable along the receiver line. The author and man overboard monitoring the progress of the advancing Cable boat from the back deck of the recording vessel. (b) Stack pile of OBC cables (inset above) with Digital Acquisition Module (arrowed)).

The recording vessel was anchored dynamically, connected to the cables, and checked the electrical integrity of the cables and sensor groups. During recording, the spread is rolled through the stationary cables in the same manner used in land recording operations. Typical cell, receivers, and source geometry used in the OBC Seismic survey in the study area offshore Niger Delta is shown in Figure 7.

The shooting vessel, towing only the airgun array, shoots a swath of lines parallel to the

bottom-Cables. When the swath is completed, one bottom-Cable is retrieved and re-deployed for the next swath. This process is repeated until the 3D survey is complete. Because the bottom-cables are stationary on the ocean's bottom and the shooting boat tows only an airgun array, lines can be shot directly adjacent to obstacles, where encountered. A schematic of the OBC recording vessel and the 4-receiver line configuration used is similar to what is shown in Figure 8.



**Figure 7:** Typical Cell, Receivers, and Source Geometry used in the OBC Survey in the South Atlantic, Offshore Niger Delta.

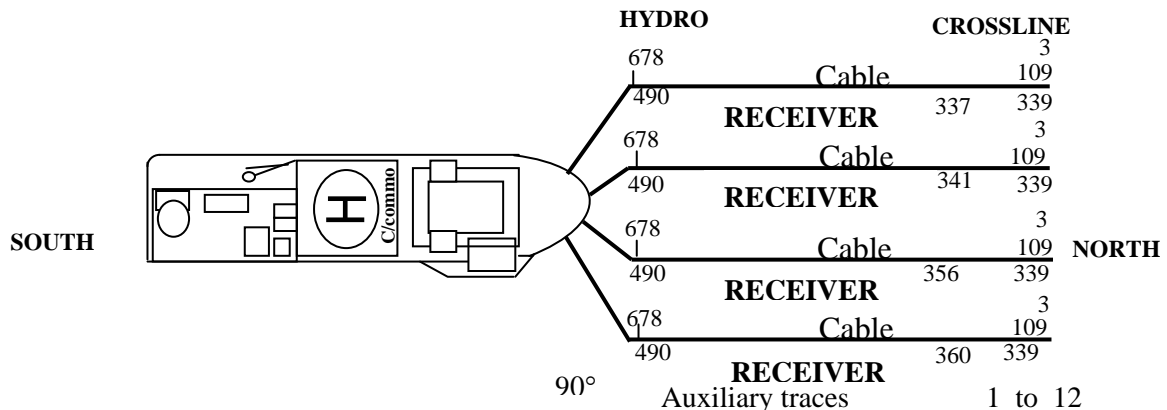

**Figure 8:** The Schematics of a Typical OBC Recording Vessel and a 4-Receiver Line Configuration used during this Survey.

## OBC SOURCE PATTERN

The source array used consists of Compact Sleeve Source (CSS™) array. It consists of 2 sub-arrays with 8 guns per sub-array. By using high efficiency external sleeve guns in combination with dual gun cluster for larger volume array elements, Western's CSS™ array matches the acoustic output of conventional arrays having nearly twice the volume and a similar number of guns. The resulting signature exhibits a balanced amplitude spectrum that is rich in both high and low frequencies.

## QUALITY CONTROL, RECORDING, PROCESSING AND SAMPLE RESULTS DATA QUALITY EVALUATION AND COORDINATION

The Seismic Prospect Evaluation and Co-ordination System (SPECS) software package was used in the design, implementation, and management of the OBC 3D seismic survey. SPECS includes a wide range of planning and QC functions allowing an in-depth analysis of all aspect of the seismic surveying. These functions include the following:

- i). Definition of image area and migration aperture outline.
- ii). Definition of survey boundaries and possible obstructions.
- iii). Mullet-option of creation of planned recording geometry.
- iv). Viewing and plotting of cell attributes generated from the planned recording geometry.
- v). Computation of source detector and cell statistics.
- vi). Ability to look at multiple surveys of different orientations, type of vintages as one prospect.
- vii). Generating of pre-plot co-ordinates for surveying/navigation
- viii). Production of scaled and annotated prospect maps.

- ix). Import and export of shooting geometry/lists in UKOOA, Standard Shell Processing Support (SPS) or Omega geometry database formats.

The SPECS system was primarily used in the field to check the fold coverage shots during the job. Processed UKOOA source and receiver positions were converted to SPS format and then binned onto the SPEC grid to check the fold of coverage achieved. Bad shots were edited out of the SPS data sets during processing and therefore did not contribute to the fold as calculated by the SPECS as the actual fold achieved on the ground. A coverage plot was produced on completion of each swath and on request. The final coverage plots were produced from the SPECS grid.

Since the survey was designed in the SPECS, and hence was based on the grid system. The grid was defined as the station numbers in the Shotline ("X" in the Cartesian co-ordinate system) and receiver line ("Y" in the Cartesian system) direction. This grid was given a reference point outside of the survey area, this reference having grid co-ordinates of a sufficiently high value such that should it be necessary to extend the survey, the question of negative shot locations does not have to be dealt with. All receiver and source geometry patterns were defined relative to this reference point interval of source and receiver points in the ground, rather than Eastings or Northings.

The grids were set up in the survey such that the cell size was 12.5m in the crossline or the Shotline direction, or 18.75m in the inline or receiver direction. (See Figure 7). Onboard recording of the seismic operation and quality control (QC) functions are performed by QC geophysicists in the recording room during the time of seismic data acquisition. This process monitors the data quality and provides onboard quality control to ensure strict adherence to the predetermined acquisition parameters and ensure high fidelity in the data obtained. Figure 9 shows QC geophysicists and the author in the recording room keeping track of the survey progress and performing onboard data processing during the OBC Seismic data acquisition in the Niger Delta.





**Figure 9:** Quality Control (QC) Geophysicists and the Author in the Recording Room Keeping Track of the Survey Progress and Performing On-Board Data Processing during the OBC Seismic Data Acquisition in the Niger Delta.

### **SYNTRAK 960 MULTIPLE STREAMER TELEMETRY SYSTEM**

The Syntron Syntrak 960 Multiple Streamer Telemetry System (MSTS) is a multiple line cable data acquisition and recording system that is capable of acquiring, processing and recording data at a one millisecond sample rate from up to eight cables simultaneously. However for the current OBC application, it is configured for four cables at two-millisecond sample rate.

### **SYNTRAK 960 DATA ACQUISITION MODULE**

The Data Acquisition Module (DAM) devices are placed with equal spacing along the cable length. Between each adjacent pair of modules are three receiver groups of four evenly spaced component sensors (for multi-sensor seismics). The sensors may be dual (2C) or multicomponent, (4C) sensor group.

The function of the DAM is to amplify, filter, multiplex and digitize the wide dynamic range seismic signals received by the hydrophones and transmits to the recording interface board. A stack pile of the OBC cables with the digital acquisition module (DAM) is also shown inset (Figure 7b).

### **OBSERVER'S LOG AND REPORT FORMAT**

The observer's reports are prepared for each shotpoint. The reports on each includes Positioning information, number of misfires (if any), number of unacceptable offline, maximum offline and other necessary nautical and technical information. The observer's report begins each Line or Line Segment on a new page, which are in turn numbered consecutively. The observer's data are produced in a printed format/reports with the data recorded on tape cartridge as expanded header information or on flexible disks in ASCII format. Reports of rejected lines or line-segments were sent to the processing (QC) centre clearly labelled "Do Not Process."

### **DATA PROCESSING: BASIC PROCESSING STEPS**

The basic onboard processing steps for the seismic data so obtained is highlighted below:

- a). Two-into-one trace summation of adjacent receiver groups, after NMO with regional velocity function, to create full-fold-CDP interval.
- b). Anti-alias filtering appropriate to twice the recorded time sampling interval.
- c). Re-sampling to the half the recorded time sampling interval.
- d). Gain application trace scaling.
- e). KF filtering.
- f). Whitening de-convolution.
- g). Predictive de-convolution.
- h). Stacking velocity analysis (to be included with data shipped).
- i). Normal moveout (NMO) with interpreted velocity.
- j). Stack.
- k). 2D Migration.

- l). Spectral analysis in three stages (shallow, intermediate, deep) of stack and migrated sections at 5000m intervals along the recording sail pass (to be included with data shipped).
- m). Time variant band-pass filter and display gain (trace scaling) for stack and migrated sections.
- n). Seismic and positioning data merge and QC, ending with SEG Y format, for both stacked and migrated sections.
- o). Create 3D velocity field, load P-wave data into the cube and create time slices from the cube (Mayne, 1962; Yilmaz, O. 1987; Linear, 1994).

**NOTE:** A near trace cube comprising 3 fold stacked data processed with the runstream stated immediately above except velocities for stacking were those derived in “stacking velocity

analysis” above, and neither KF filtering, migration, nor spectral analysis were performed. The near trace cube comprised the nearest 3 offsets in each bin of length equal to one receiver group length and width equal to one-half the crossline spacing of sources. Binning of these offsets were done using final and proven shot and receiver co-ordinates after post processing.

**SAMPLE RESULTS FROM PROCESSED DATA**

Sample results from some stages of the data processing such as time sections brute stacks and 3D time slices are included here. Figure 10 contains the result of the processing of the dual sensor data for the infill area 3 from the inline stack for shotline number 5859. The stacks have been produced with brute velocities

A sample of 2 second's time slices of the cube in a scale of 1:200,000 is presented in Figure 11.

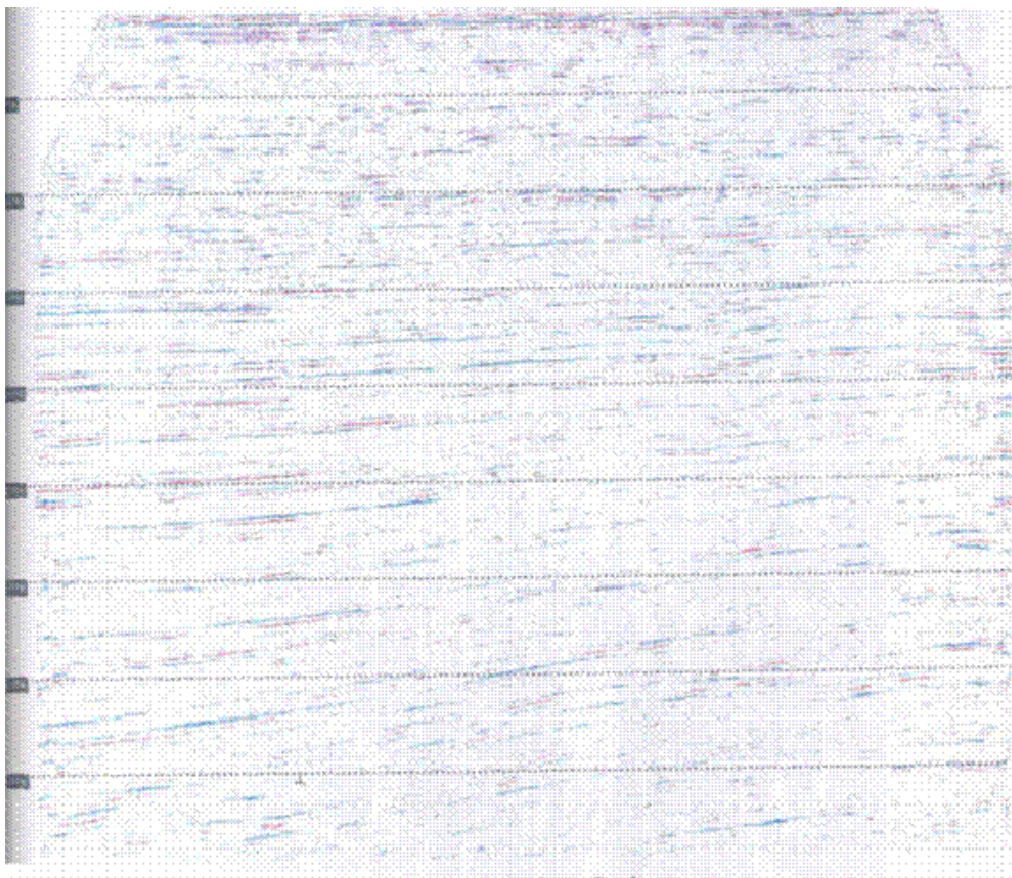

**Figure 10:** The Results of the Processing of the Dual Sensor Data for the Infill Area 3 from the Inline Stack for Shotline Number 5859.

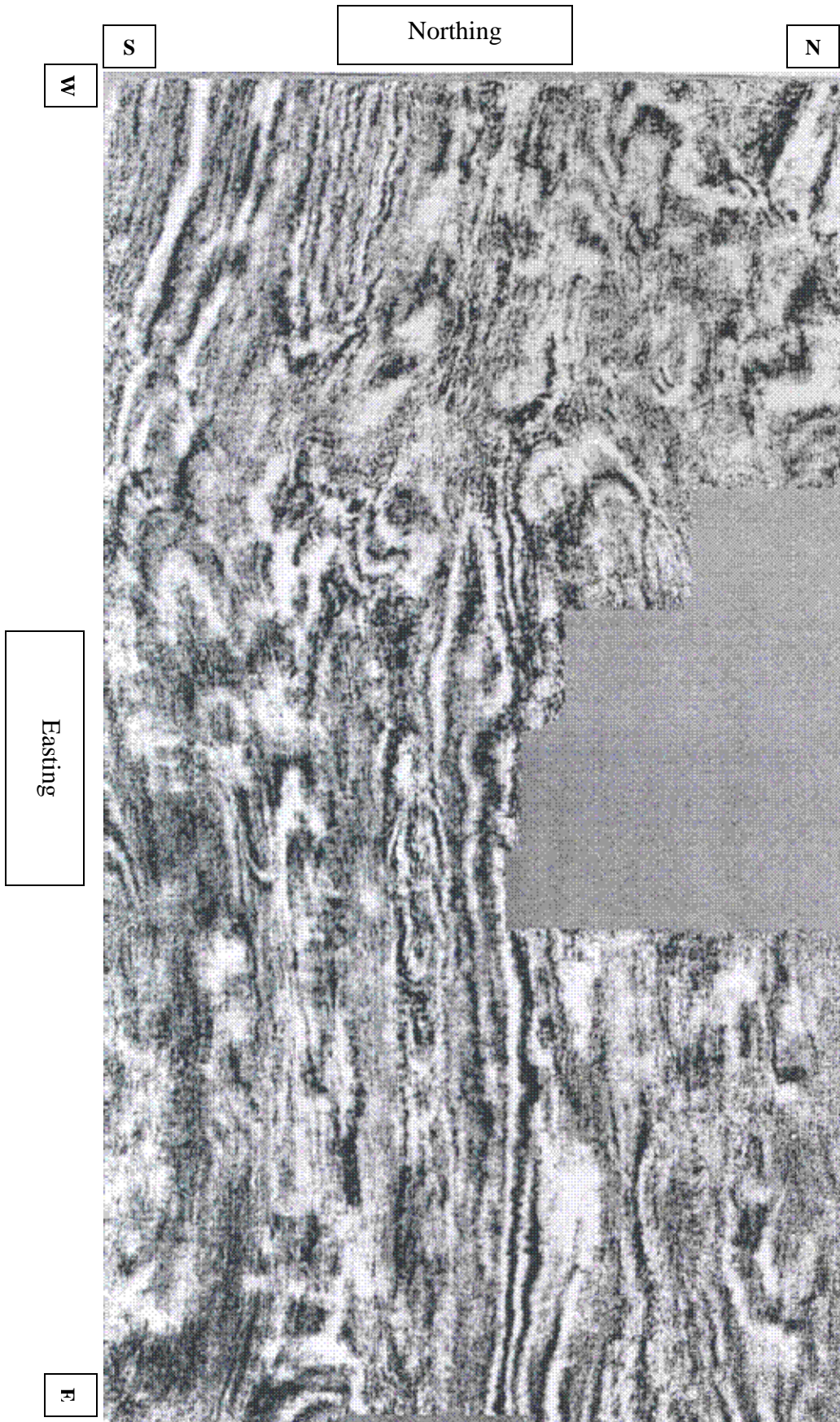

**Figure 11:** A Sample of Timescale at 2000 milliseconds of the 3D Cube in a scale of 1:200,000.

## SUMMARY AND CONCLUSION

The dual sensor Ocean-Bottom Cable method of seismic acquisition deploys the sensors' cables on the seafloor and the sensors record both the velocity and the pressure data from the propagating seismic waves. It has demonstrated its effectiveness in providing broad-band, high resolution reflection data without the potential contamination of water-column reverberations as is seen in the preliminary onboard processed data, particularly, the 3D time slices obtained for the just concluded OBC survey in the Niger Delta, offshore Nigeria. Moreover, because the cables and the source vessels were deployed directly adjacent the obstacles, the dual sensor method proved effective in generating high 3D data in the infill areas.

The superior imaging using the dual sensor Ocean Bottom Cable (OBC) seismic method is thus evident in this pioneer dual sensor OBC acquisition in the Niger Delta as is evident in these results. Because of its repeatability and superior imaging qualities, it thus provides a good tool for the emerging 4D (time-lapse) seismics.

## ACKNOWLEDGEMENT

I thank Prof. K.M. Onuoha and Dr. L. I. Mamah who read through this work. I also commend the following staff members of Shell Petroleum Development Company for the various roles they played during the course of this research: First, I am grateful to Messrs F. Akinbobola, (then Head, DPE-UNI), Promise Egele (then Manager, Subsurface Development, East - DTE), A.A. Ezebilo (then Head/Chief Geophysics, DTE-GPH) and L.C. Okara (then Head, Seismic Acquisition, DTE-GPH).

I also extend my gratitude to the management of Western Geophysical, especially the party chief of Party 66 Atlantic Explorer crew Mr. Jim Roberts for his unalloyed support during my field work in the Ocean Bottom Cable (OBC) seismic exploration in the South Atlantic Ocean, offshore Niger Delta, Nigeria. I am also grateful to other seismic crew members onboard especially Messrs. Craig Bowen, Cherry Lonoso, Fabrice Mandraux, and Ronny, among others for the pains they took in conducting me through every

detail of the OBC seismics during the field operation under study.

## REFERENCES

1. Barr, F.J. 1995. "Dual Sensor Ocean Bottom Cable Technology is Improving Hydrocarbon Recovery". *In-Depth*. 1:15.
2. Barr, F.J. and Sanders, J.I. 1989. "Attenuation of Water Column Reverberations Using Pressure and Velocity Detectors in a Water-Bottom Cable". Presented at the 59th Annual meeting of the Society of Exploration Geophysicists (Dallas) Texas.
3. Beasley, C., Chambers, R., Workman, R., Craft, K., and Meister, L. 1997. "Repeatability of 3D Ocean Bottom Seismic Surveys". *In-Depth*. 4:12-19.
4. Bufkin, S. and Magruder, R. 1985. "Positioning Requirements for 3D Seismic Survey". *In-Depth*. 3:10.
5. Caffarelli, W.J. 1995. "Subsurface Imaging with Ocean Bottom Seismics". *World Oil*. 216(10):91-98.
6. Edington, L., Caffarelli, W.J., and Starr, J. 1993. "Ocean-Bottom Receiver Location". Presented at the 25th Annual Offshore Technology Conference, Houston, Texas.
7. Gaiser, J. and Neil, J. 1996. *Multicomponent OBC Captures Shear-wave Rock Properties*. Western Atlas Inc.: London.
8. Linear, C.L. 1994. *3D Seismic: Acquisition, Processing and Interpretation*. Cambridge University Press: Cambridge.
9. Mayne, W.H. 1962. "Common Reflection Point Horizontal Stacking Techniques". *Geophysics*. 27:927-928.
10. Ugbor, C.C. 1999. "3D Seismic Acquisition Geometries, and 3D Dual-Sensor OBC Technology: A case Study from an OBC concession in the Atlantic Ocean, Offshore Niger Delta, Nigeria". M.Sc. Thesis presented to the Department of Geology, University of Nigeria, Nsukka.
11. Western Atlas. 1998. *An introduction to Ocean-Bottom Multicomponent Seismics*. Western Atlas Inc.: London.
12. Yilmaz, O. 1987. *Seismic Data Processing*. SEG: Tulsa.

## ABOUT THE AUTHOR

**Charles Chibueze Ugbor**, is a Geophysics lecturer in the Department of Geology, University of Nigeria, Nsukka which he joined after serving as a Research Fellow in the Shell Professorial Chair in Geology of University of Nigeria. He is a Chattered Geoscientist (GEM) and the founder and Faculty Sponsor of the Student Chapter of Society of Exploration Geophysicists (SEG) in the University of Nigeria. As a recipient of the best research award in Geosciences among all the Nigerian universities in his graduating year in Geology by the Nigerian Mining and Geosciences Society (NMGS), and a holder of M.Sc. in Applied Geophysics, his research interest spans Geology, Petroleum Geophysics and Reservoir Geophysics/Petrophysics. He is currently running a PhD research project as an SEG Scholar in the University of Nigeria. Charles. C. Ugbor is a member of Association of Geoscientists for International Development (AGID) (Life); Society of Exploration Geophysicists (SEG) (Active); Nigerian Mining and Geosciences Society (NMGS) (Corporate); AAPG and NAPE.

## SUGGESTED CITATION

Ugbor, C.C. 2007. "First Dual-Sensor Ocean Bottom Cable 3D Seismic Acquisition South Atlantic Ocean, offshore Niger Delta, Nigeria". *Pacific Journal of Science and Technology*. 8(1):36-48.

