

## Analysis of Radial-Flow Impellers of Different Configurations.

A.T. Oyelami, Ph.D.<sup>1\*</sup>; S.B. Adejuyigbe, Ph.D.<sup>2</sup>; M.A. Waheed, Ph.D.<sup>2</sup>; A.K. Ogunkoya, M.Eng.<sup>1</sup>; and D. Iliya, HND<sup>1</sup>

<sup>1</sup>Engineering Materials Development Institute, PMB 611 Akure, Ondo State, Nigeria.

<sup>2</sup>Department of Mechanical Engineering, University of Agriculture, Abeokuta, Nigeria.

E-mail: [atoyelami@yahoo.com](mailto:atoyelami@yahoo.com)\*

### ABSTRACT

The performance efficiency of all centrifugal blowers that utilize radial-flow impellers depends greatly on the mode of impelling. This work therefore focuses on different designs of two of the most important parts of the blower – the impeller and the volute casing – together with the evaluation of their operational performances. In all the designs, fluid enters the inlet port at the center of the rotating impeller which is the suction eye. As the impeller spins, it thrusts the fluid outward radially, causing centrifugal acceleration. As it does this, it creates a vacuum in its wake, drawing even more fluid into the inlet. The volute casing performs the function of slowing the fluid and increasing the pressure. The impeller, driven by the blower shaft adds the velocity component to the fluid by centrifugally casting the fluid away from the impeller vane tips.

The amount of energy given to the fluid is proportional to the velocity at the edge or vane tip of the impeller. Whereas two designs of the volute casings done were essentially the same, differing only on the direction of impelling; seven different impellers were designed and developed. The differences in the impeller designs are not only attributable to the vane profile but also on whether the impeller is open or close. The performance evaluation carried out with the aid of an anemometer revealed that the closed impeller with backward curved vanes has the best performance cum efficiency with respect to the output speed and flow rate. The designed and developed closed-impellers include backward and forward curved vanes while the open-impellers comprise of backward and forward curved; backward and forward inclined; and radial vanes.

(Keywords: radial-flow impeller, volute casing, suction eye, vane, anemometer)

### INTRODUCTION

The impeller is often considered an integral part of the suction motor since its housings and the motor are assembled as a unit. The impeller, driven by the blower shaft adds the velocity component to the fluid by centrifugally casting the fluid away from the impeller vane tips. The key idea here is that the energy created is *kinetic energy*. The amount of energy given to the fluid corresponds to the velocity at the edge or vane tip of the impeller. Addison (1995) established that the faster the impeller revolves or the bigger the impeller is, the higher will be the velocity of the fluid at the vane tip and the greater the energy imparted to the fluid.

The blower can therefore be described as a device, which converts 'driver' energy to kinetic energy in a fluid by accelerating it to the outer rim of a revolving device known as an impeller. The impeller is always placed directly onto the shaft of the Suction Motor so that it spins at a very high speed.

The principle involved in the design of a blower is similar in virtually every important aspect as that of a centrifugal pump except for the fact that the term "centrifugal pump" is often associated with liquid as its working fluid while the blower is meant to work on air (Edward, H.S. 1995). The effects of centrifugal force acting upon the spinning air within the impeller create the suction. As the impeller rotates, the spinning air moves outward away from the hub, creating a partial vacuum which causes more air to flow into the impeller.

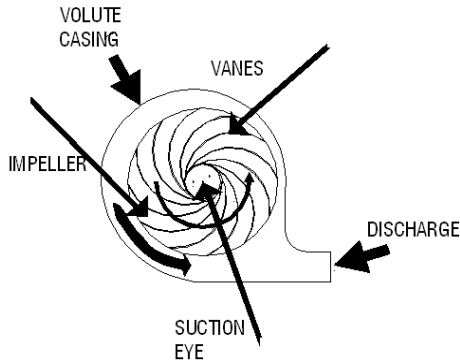

**Figure 1:** Sectional Drawing of a Blower.

Figure 1 illustrates a cross-section of the blower designed. Fluid enters the inlet port at the center of the rotating impeller, or the suction eye. As the impeller spins in a counter-clockwise direction, it thrusts the fluid outward radially, causing centrifugal acceleration. As it does this, it creates a vacuum in its wake, drawing even more fluid into the inlet. Centrifugal acceleration creates energy proportional to the speed of the impeller (Csanady 1981). The faster the impeller rotates, the faster the fluid movement and the stronger its force. Impellers are the rotating blades that actually move the fluid. They are connected to the drive shaft that rotates within the blower casing. The impeller is designed to impart a whirling or motion to the air in the blower.

### IMPELLER'S BASIC THEORY

As the impeller rotates, it creates vacuum at its inlet suction side through centrifugal force. In turn, the impeller creates a positive pressure, inducing a force of air on the discharge side. Impeller is the most important part of the blower components because of the fact that its performance inadvertently determines the blower's performance.

An impeller is essentially a disk shaped structure with vanes that create the actual suction in a blower. The impeller is always placed directly onto the shaft of the electric motor so that it spins at a very high speed. The effects of centrifugal force acting upon the spinning air within the impeller create the suction. As the impeller rotates, Von Cube and Steimle (1981) confirms that the spinning air moves outward away from the hub, creating a partial vacuum which causes more air to flow into the impeller.

The most important impeller parameters can be grouped into three categories:

- Geometrical Parameters: Tip diameter, hub diameter and tip width;
- Operating conditions: Inlet total pressure, inlet total temperature and fluid density;
- Performance characteristics: mass flow parameter, pressure ratio and specific speed.

### Technical Performance Data

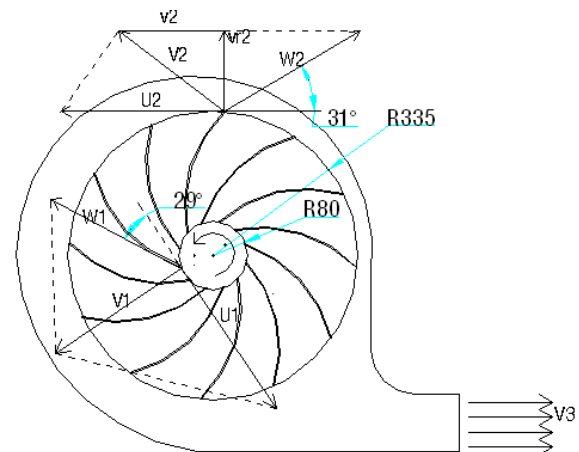

**Figure 2:** Impeller Cross-Section in the Blower Volute's Casing Showing the Velocity Diagrams.

Figure 2 shows the velocity triangle of the air flow leaving the impeller. Since there are no inlet guide vanes, the entering flow has no tangential component of motion. The entering flow is therefore in radial direction, and  $v_{r1}$  which is the radial component of the absolute velocity is the same as the inlet velocity,  $V_1$ .

That is  $v_{r1} = V_1$ .

It is assumed that the flow is completely guided by the blades and that the flow angles coincide with the blade angles.

Inlet Vane Angle  $\beta_1 = 29^\circ$

Outlet Vane Angle  $\beta_2 = 31^\circ$

Volute Inside radius  $r_1=0.08\text{m}$

Volute Outside radius  $r_2=0.335\text{m}$

Vane Width at the Suction Eye  $b_1=0.0355\text{m}$

Vane Width at the tapered end  $b_2=0.024\text{m}$

Rotational Speed  $N=3430\text{rpm}$

Linear Speed at the inlet is:

$$U_1 = r_1\omega = \frac{2\pi \times 3430 \times 0.08}{60} = 28.74\text{m/s}$$

$$V_1 = v_{r1} = U_1 \tan \beta_1 = 28.74 \tan 29 = 15.93\text{m/s}$$

The expected flow rate is:

$$\dot{Q} = 2\pi r_1 b_1 v_{r1} = 2\pi \times 0.08 \times 0.0355 \times 15.93 = 0.2842\text{m}^3/\text{s}$$

Applying continuity concept at the blower discharge:

$$V_3 = \frac{\dot{Q}}{A_3} = \frac{0.2842}{0.134 \times 0.134} = 15.83\text{m/s}$$

Applying Bernoulli equation between the room and blower discharge at 3:

$$\frac{P_{atm}}{\rho g} + (\Delta h_t)_{1 \rightarrow 2} = \frac{P_{atm}}{\rho g} + \frac{V_3^2}{2g}$$

where,

$V_3$  = the discharge velocity

$\dot{Q}$  = Fluid flow rate

$A_3$  = Cross-sectional area at the discharge end

$P_{atm}$  = Atmospheric pressure

$(\Delta h)_{1 \rightarrow 2}$  = The total head change

$\rho$  = Air density

$g$  = acceleration due to gravity

The total head change imparted to the flow by the blower is then:

$$(\Delta h_t)_{1 \rightarrow 2} = \frac{V_3^2}{2g} = \frac{15.83^2}{2 \times 9.81} = 12.77\text{m}$$

$$\text{But } (\Delta h_t)_{1 \rightarrow 2} = \frac{U_2 v_{\theta 2} - U_1 v_{\theta 1}}{g}$$

(Alan M. 1979).

where  $v_{\theta}$  is the tangential component of the fluid absolute velocity.

Since the flow enters radially,  $v_{\theta 1} = 0$ ,

$$v_{\theta 2} = \frac{(\Delta h_t)_{1 \rightarrow 2}}{U_2}$$

where,

$$U_2 = r_2\omega = \frac{2\pi N}{60} r_2 = \frac{2\pi \times 3430}{60} \times 0.335 = 120.33\text{m/s}$$

$$v_{r2} = \frac{\dot{Q}}{2\pi r_2 b_2} = \frac{0.2842}{2\pi \times 0.335 \times 0.024} = 5.625\text{m/s}$$

$$\tan \beta_2 = \frac{v_{r2}}{U_2 - v_{\theta 2}}$$

$$v_{\theta 2} = U_2 - \frac{v_{r2}}{\tan \beta_2} = 120.33 - \frac{5.625}{\tan 31} = 110.97\text{m/s}$$

$$V_2 = \sqrt{v_{\theta 2}^2 + v_{r2}^2} = \sqrt{110.97^2 + 5.625^2} = 111.1\text{m/s}$$

The power input to the blower is:

$$P = \rho \dot{Q} g h = 1.239 \times 0.2842 \times 9.81 \times 12.77 = 44.11\text{W}$$

## METHODOLOGY

Apart from dimensions and materials used for construction, what essentially differentiate two impellers from each other are:

1. Shape / Profile of the Vane
2. Presence / Absence of Guiding Vanes
3. Whether the impeller is closed or open

Since the aim of this work is to evaluate performance of blowers of different impeller/vane profiles, seven different possibilities of impeller designs were explored. They all had same base-plate dimensions without guiding vanes. These include

1. Backward-Curved-Vane Open Impeller
2. Forward-Curved-Vane Open Impeller
3. Backward-Curved-Vane Closed Impeller
4. Forward-Curved-Vane Closed Impeller
5. Backward-Inclined-Vane Open Impeller
6. Forward-Inclined-Vane Open Impeller
7. Radial-Vane Open Impeller

(See Plates 1 – 4)

Two volute casings were constructed to allow for clockwise and anticlockwise rotation of the impellers (Figures 3 – 6 and Plates 5 – 6). Each of the impellers was subjected to dynamic balancing (Plate 7) where out-of-balance mass was added to ensure stability and minimize vibration (Plate 8).



**Plate 1:** Forward-Inclined Impeller under Construction.



**Plate 2:** Backward Curved Impeller under Construction.



**Plate 3:** Radial Impeller under Construction.



**Plate 4:** Newly Constructed Backward Curved Closed Impeller.

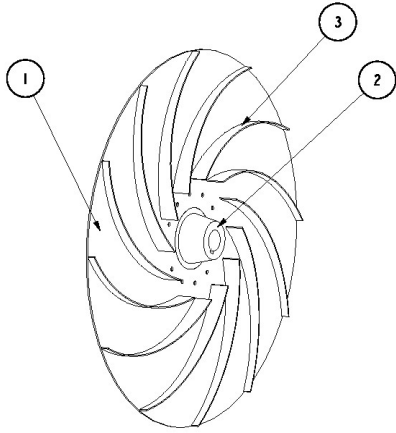

**Figure 3:** 3D Drawing of Backward-Curved-Vane Open Impeller [1) base-plate; 2) Backward-Curved-Vane; 3) Coupler].

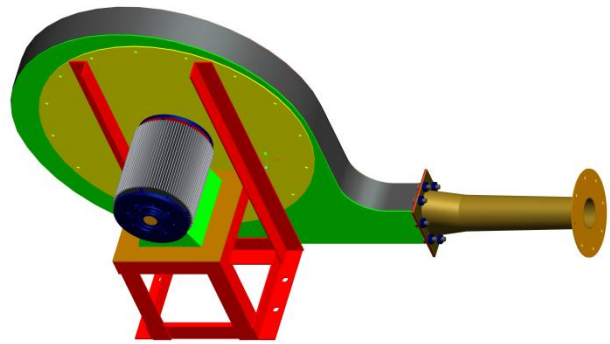

**Figure 6:** 3D Assembly Drawing of the developed Blower (Shaded).

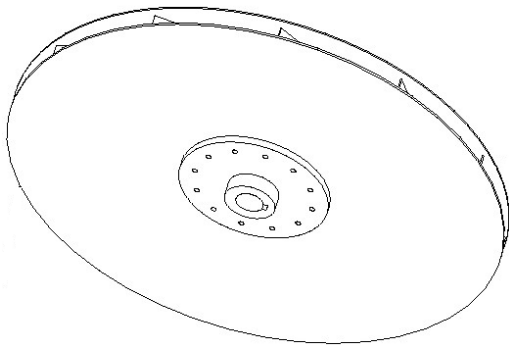

**Figure 4:** 3D Drawing of Backward-Curved-Vane Closed Impeller.



**Plate 5:** Anti-Clockwise Volute Casing under Construction.

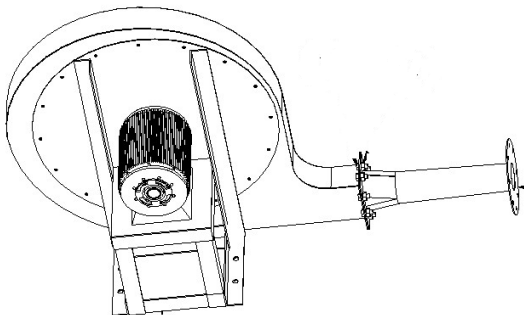

**Figure 5:** 3D Assembly Drawing of the developed Blower (unshaded).



**Plate 6:** Clockwise and Anti-Clockwise Volute Casings under Construction.



**Plate 7:** Radial Impeller undergoing Dynamic Balancing.



**Plate 8:** Out-of-Balance Mass added for Impeller Dynamic Balance.



**Plate 9:** Blower Being Assembled for Test Running.

## RESULTS AND DISCUSSIONS

As previously explained, the impeller is the most important part of the blower components because of the fact that its performance inadvertently determines the blower's performance. It is the impeller's vanes that create the actual suction in a blower. The effects of centrifugal force acting upon the spinning air within the impeller create the suction. As the impeller rotates, the spinning air moves outward away from the hub, creating a partial vacuum which causes more air to flow into the impeller. The impeller speed, which determines the suction rate, was measured at different points, for different vane types/ profiles, from the outlet/discharge of the blower and the results are as shown in Table 1.

The measurements were done with the aid of an Airflow Anemometer (see plates 10 – 13). The graph showing Blower Speed Variations with different types of Impeller is shown in Figure 7.









**Plate 10:** Anemometer Used for Blower Performance Characterization (for Airflow, Temperature, Relative Humidity and Air Velocity).



**Plate 11:** Blower Performance being Measured at a Distance X.

**Table 1: Blower Performance Characteristics**

S/N	Vane Type	Vane Profile	Impeller Type	Speed (m/s) at various distances (0m – 5m) from the outlet										
				0m	0.5m	1m	1.5m	2.0m	2.5m	3.0m	3.5m	4.0m	4.5m	5.0m
1.	Backward Curved		Open	58.9	43.8	34.7	26.5	20.1	18.8	16.3	15.2	13.4	11.8	9.9
2.	Forward Curved		Open	49.6	41.8	29.0	21.7	17.6	14.8	12.2	10.7	9.2	8.1	7.2
3.	Backward Curved		Closed	63.8	49.9	38.3	30.2	23.2	21.5	19.1	17.4	15.1	14.5	12.7
4.	Forward Curved		Closed	54.7	45.2	34.8	24.6	19.8	17.9	15.2	13.2	11.1	9.7	8.6
5.	Backward Inclined		Open	56.3	39.1	29.3	23.3	18.2	17.7	15.8	14.8	12.5	11.2	9.5
6.	Forward Inclined		Open	50.7	40.3	27.9	19.6	17.1	15.0	12.1	9.9	8.7	7.8	7.0
7.	Radial		Open	53.2	41.7	28.1	20.9	17.0	16.4	12.4	11.8	10.7	9.4	9.1



**Plate 12:** Blower Performance being Measured at a Distance Y.



**Plate 13:** Blower Performance being Measured at a Distance Z.

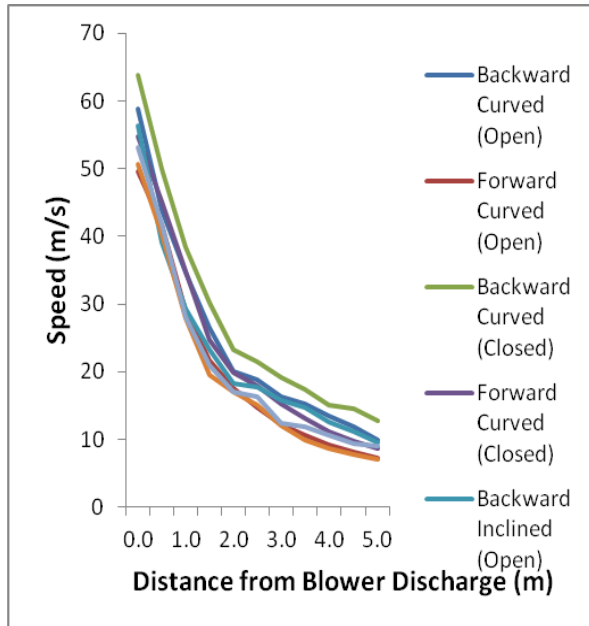

**Figure 7:** Blower Speed Variations with Different Types of Impeller.

The Impeller with backward curved vane under close configuration gives the best performance among the blowers designed and developed. Graphs of the mechanical efficiency versus the flow coefficient for various speeds (revolutions per minute) of the impeller of the blower are as shown in Figure 8.

The mechanical efficiency at a particular flow coefficient is noted to be higher for lower rpm because of the tendency for more instability at higher rpms. As established in literature (<http://www.flowmetric.com/products/> 2006 and <http://www.fanair.com> 2006), the flow and pressure coefficients are dependent on blades angles and blade widths.

Results of simulation of the Failure Analysis using finite elements approach are as shown in Table 2 and Figures 9 to 11.

**Table 2:** Analysis Results of the developed Impellers.

<b>Principal System of Units:</b>			
Length:	mm	Force:	N
Time:	sec	Temperature:	C
<b>Model Type:</b> Three Dimensional			
Points:	2650		
Edges:	12865		
Faces:	17869		
<b>Mass Moments of Inertia about WCS Origin:</b>			
Ixx:	2.63955e+02		
Ixy:	-6.11663e-03	Iyy:	2.63948e+02
Ixz:	-5.80896e-03	Iyz:	3.34848e-03
Izz:	5.24559e+02		
<b>Principal MMOI and Principal Axes Relative to WCS Origin:</b>			
Max Prin	Mid Prin	Min Prin	
5.24559e+02	2.63959e+02	2.63945e+02	
WCS X:	-2.22907e-05	8.66545e-01	4.99100e-01
WCS Y:	1.28491e-05	-4.99100e-01	8.66545e-01
WCS Z:	1.00000e+00	2.57289e-05	9.03738e-09
<b>Center of Mass Location Relative to WCS Origin:</b>			
(-4.39156e-02, 2.53674e-02, -3.29316e+00)			
<b>Mass Moments of Inertia about the Center of Mass:</b>			
Ixx:	2.63808e+02		
Ixy:	-6.13174e-03	Iyy:	2.63801e+02
Ixz:	-3.84810e-03	Iyz:	2.21581e-03
Izz:	5.24559e+02		
<b>Principal MMOI and Principal Axes Relative to COM:</b>			
Max Prin	Mid Prin	Min Prin	
5.24559e+02	2.63812e+02	2.63797e+02	
WCS X:	-1.47580e-05	8.66543e-01	4.99102e-01
WCS Y:	8.49793e-06	-4.99102e-01	8.66543e-01
WCS Z:	1.00000e+00	1.70298e-05	1.92473e-09
S/N	Name	Value	Convergence
1.	max_disp_mag	5.130001e-01	0.7%
2.	max_disp_x	-5.123789e-01	0.7%
3.	max_disp_y	-5.101572e-01	0.8%
4.	max_disp_z	-3.277257e-02	0.7%
5.	max_prin_mag	7.723517e+02	8.6%
6.	max_stress_prin	7.723517e+02	8.6%
7.	max_stress_vm	6.497699e+02	7.8%
8.	max_stress_xx	1.935540e+02	16.6%
9.	max_stress_xy	6.749337e+01	0.9%
10.	max_stress_xz	1.502379e+02	17.2%
11.	max_stress_yy	1.908066e+02	6.8%
12.	max_stress_yz	1.497421e+02	20.5%
13.	max_stress_zz	7.263497e+02	7.8%
14.	min_stress_prin	-4.043473e+02	13.8%
15.	strain_energy	2.893968e+03	1.2%



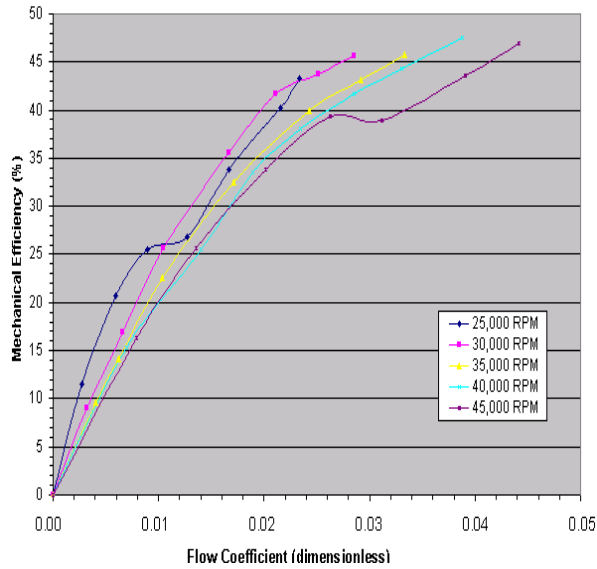
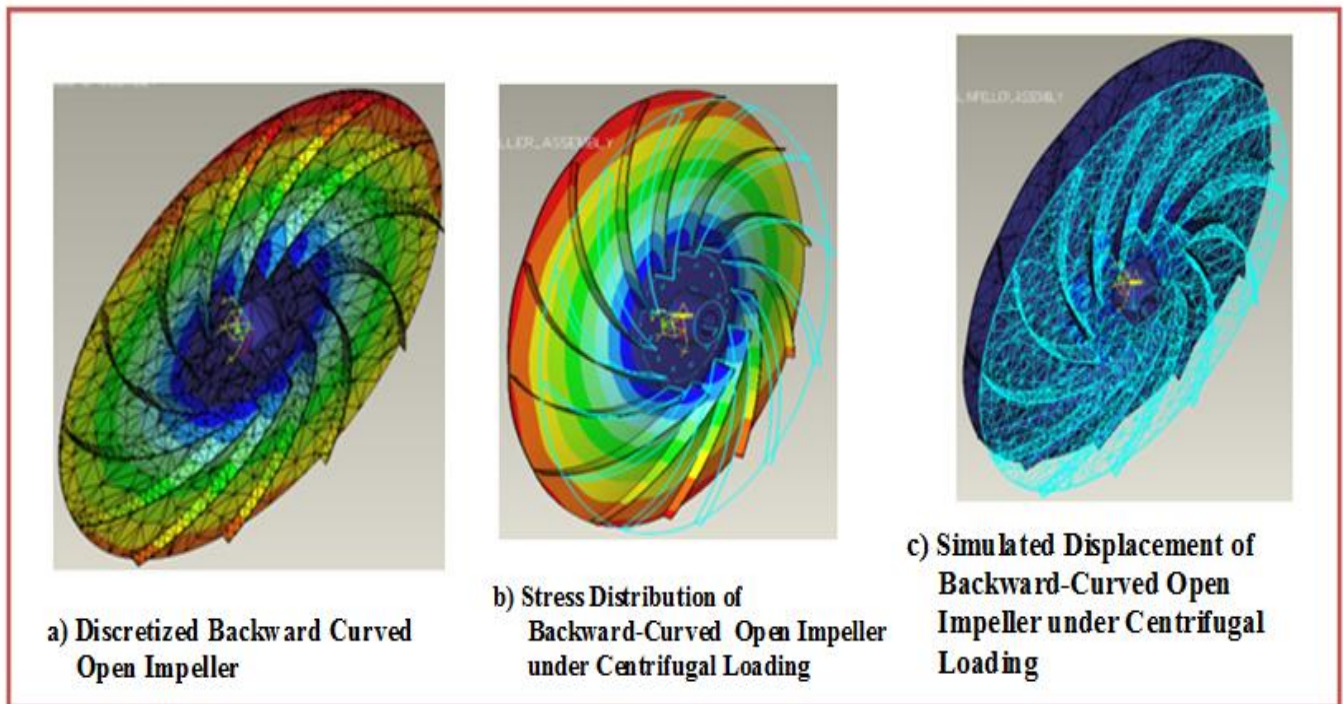

**Figure 8:** Variation of Blower Mechanical Efficiency with Flow Coefficient for different RPMs.

## CONCLUSION

The performance evaluation of the developed blower with different impeller/vane profiles revealed that:

- the performance differences in the seven (7) impeller designs are not only attributed to the vane profile but also on whether the impeller is open or close.
- the closed impeller with backward curved vanes has the best performance cum efficiency with respect to the output speed and flow rate.



**Figure 9:** Failure Analyses of the Developed Impellers.

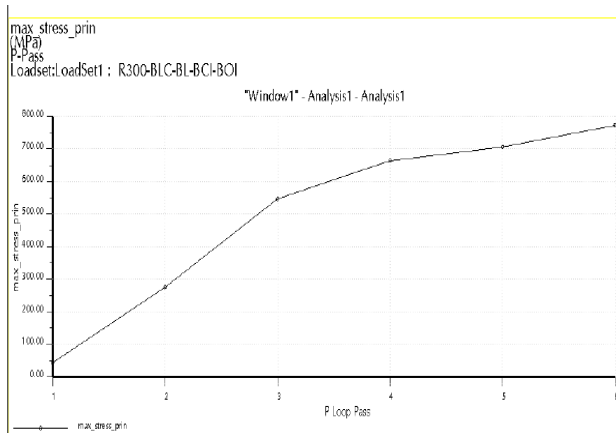

**Figure 10:** Test of Convergence through maximum Von Mises with P-Loop.

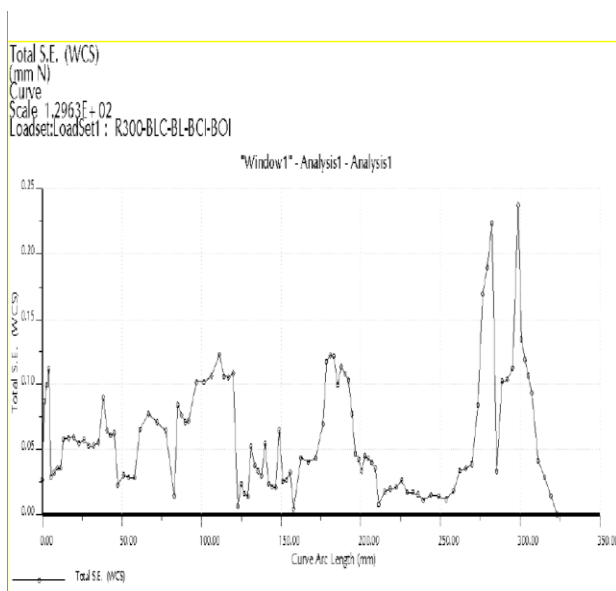

**Figure 11:** Strain Energy along the Length of the Vane.

The level of convergence of results obtained from the failure analyses equally indicate the reliability of the results that the impeller will not fail in service. Therefore, the data obtained can serve as a tool in selecting blower design type for different applications. The qualitative and quantitative analyses have also shown that backward curved vanes have the best performance cum efficiency in industrial blowers applications.

## REFERENCES

1. Addison, H. 1995. *Centrifugal and Other Rotordynamic Pumps, 2nd ed.* Chapman & Hall: London, England
2. Alan, M. 1979. *Engineering Fluid Mechanics.* McGraw-Hill Int. Book Co.: Auckland, New Zealand.
3. Budynas–Nisbett. 2006. *Shigley’s Mechanical Engineering Design. 8th Edition.* McGraw–Hill Primis: New York, NY.
4. Csanady, G.T. 1964. *Theory of Turbomachines.* McGraw-Hill: New York, NY.
5. Dryden, I.G.C. 1982. *The Efficient Use of Energy.* Butterworth: Surrey, England.
6. Horlock, J.H. 1984. *Axial Flow Compressors.* Butterworth: London, England.
7. Edward, H.S. 1995. *Mechanical Engineers Reference Book, 12th Edition.* The Bath Press: Bath, UK.
8. Oyelami, A.T. and Adejuyigbe, S.B. 2006. “The Design of a Radiation-Recuperative Heat Exchanger for a 200kg Capacity Rotary Furnace”. *AU J.T.* 10:100-4.
9. Tuton, R.K. 1984. *Principles of Turbo-Machinery.* S & FN Spon: London, UK.
10. Von Cube, H.L. and Steimle, F. 1981. *Heat Pump Technology.* Butterworth: London, UK.
11. <http://www.engineeringpage.com> (2005)
12. <http://www.fanair.com> (2006)
13. <http://www.flowmetric.com/products/> (2006)

## SUGGESTED CITATION

Oyelami, A.T., S.B. Adejuyigbe, M.A. Waheed, A.K. Ogunkoya, and D. Iliya. 2012. “Analysis of Radial-Flow Impellers of Different Configurations”. *Pacific Journal of Science and Technology.* 13(1):24-33.

 [Pacific Journal of Science and Technology](http://www.pacificjournalofscienceandtechnology.com)