

Broadband Wireless Access Solution base on OFDMA Technique in WiMAX IEEE 802.16.

F.A. Ibikunle, Ph.D., MNSE, MIEEE

Covenant University, Department of Electrical and Information Engineering,
Ota, Nigeria.

E-mail: faibikunle2@yahoo.co.uk

ABSTRACT

There is significant interest worldwide in the development of technologies for broadband wireless access systems. One of the key technologies which is becoming the de-facto technology for use in BWA systems is the orthogonal frequency division multiple access scheme. A historical perspective of orthogonal frequency-division multiplexing is given with reference to its literature. Its applications, advantages and disadvantages are reviewed. The reasons for the popularity of OFDMA is discuss and outline of some its important concepts as applied to BWA systems. The paper uses the IEEE 802.16 based WiMAX standard for highlighting some of the significant ideas in the practical use of OFDMA systems and make some comparisons analysis.

(Keywords: OFDMA, WiMAX, sub-carriers, sub-channels, broadband wireless)

INTRODUCTION

Broadband Wireless Systems (BWS) are expected to be rolled out in order to satisfy demands from various segments of society. As demand for mobile services continues to grow worldwide, system vendors and computer operators have noticed the enormous popularity of second generation mobile systems and are keen to extend this trend to BWS. Several challenges exist in the development and deployment of broadband wireless systems and research work addressing these challenges is ongoing. The orthogonal frequency division multiple access based systems are being adopted for use in different flavors of wireless systems [1].

The IEEE 802.16d and 802.16e standards which are popularly known in the industry forum as

WiMAX are being considered for BWA systems and are the first standards to use the OFDMA technique [2]. This WiMAX standard is a forum that has been driving the adoption of the technology and fostering the interoperability amongst products [3]. Other proprietary broadband wireless system which is likely to influence emerging standards like IEEE 802.20 [4] and other evolutions to 3G cellular systems [5] have also used OFDMA. Hence, there seems to be a trend emerging with respect to the use of OFDMA in broadband wireless systems and this forms a motivation for this paper. The objective of the paper is to outline the key features of OFDMA and highlight the advantages of using OFDMA in solving important technical challenges in broadband wireless systems. The WiMAX system is use as an example to showcase the practical use of the various OFDMA related concepts.

One of the challenges in wireless systems are the severe frequency selective fading caused due to the multipath channel between the transmitter and the receiver. The signal bandwidth in broadband wireless systems typically exceeds the coherent bandwidth of the multipath channel [6]. Consequently, frequency selective fading results and this leads to inter-symbol interference (ISI) which is usually dealt with by physical (PHY) layer solutions like OFDM which can address the problem [7]. Also, the use of multiple antennas to enhance spectral efficiency and reliability is almost a certainty given the findings from the latest research results in this area [6]. Hence, a transmission technique which is amenable to the use of multiple antenna schemes will be crucial in the next generation wireless systems.

In broadband wireless systems, it is expected that support for multiple users with disparate traffic requirements will be a necessity (i.e., users with low bandwidth requirements will have to be served alongside a user with high bandwidth

requirements). This implies that a medium access control (MAC) method which can satisfy these disparate requirements efficiently will be necessary in broadband wireless systems. Spectral efficiency is a major concern and tight frequency reuse is likely to be enforced by spectrum regulatory agencies. Consequently, a broadband wireless system should take multicellular deployment with tight frequency reuse into perspective so as to achieve high spectral efficiency. Thus, one can summarize the challenges in broadband wireless systems as follows:

- Frequency selective fading leading to ISI
- Incorporation of multiple antenna techniques to enhance spectral efficiency and reliability
- Handling multiple users with different service/traffic requirements efficiently
- Multicellular deployment with tight frequency reuse to achieve high spectral efficiency

This paper presents a review of the OFDM scheme, highlighting the associated research issues with reference to the literature. It then presents the combination of different multiple access schemes which can be used with OFDM. The following section focuses on the OFDMA technique and discusses it in the context of challenges in broadband wireless systems. The paper then presents a consideration of the WiMAX system as an example of the use of OFDMA, and highlights some of the important concepts. Our discourse is concluded with wide-ranging comparisons of OFDMA schemes discussed in the paper and end the paper with a conclusion.

ORTHOGONAL FREQUENCY DIVISION MULTIPLEXING

Frequency Division Multiplexing (FDM) is a technology that transmits multiple signals simultaneously over a single transmission path, such as a cable or wireless system. Each signal travels within its own unique frequency range (carrier), which is modulated by the data (text, voice, video, etc.). OFDM is a technique that distributes the data over a large number of carriers that are spaced apart at precise frequencies. This spacing provides the "orthogonality" in this technique, which prevents the demodulators from detecting frequencies other than their own. It's sometimes referred to as

multi-carrier or as discrete multi-tone modulation. Some of the benefits of OFDM are its high spectral efficiency, resiliency to RF interference and lower multi-path distortion. The transmission technique has established itself as a popular method for overcoming the frequency selective fading in broadband wireless systems [5]. The IEEE 802.11 a/g standards for wireless local area network (WLANs) [8] which are popularly known as Wi-Fi have used OFDM to achieve speeds of the order of 50Mbps in an indoor multipath environment. The discrete multi-tone (DMT) system used in the ADSL modems also have used OFDM to achieve high bit rates in the telephone channel [9]. The WiMAX standards have proposed various OFDM based methods for use in fixed and mobile environments [2]. Various systems that use the OFDM include power line communications, digital audio and video broadcasting systems, and ultra wideband based systems for short range wireless. Some of the key concepts in the OFDM include the use of orthogonal subcarriers for sending several data symbols in parallel resulting in better spectral efficiencies and simple equalization methods at the receivers.

The samples of the transmitted OFDM signal can be obtained by performing an Inverse Fast Fourier Transform (IFFT) operation on the group of data symbols to be sent in orthogonal subcarriers. Similarly, the recovery of data symbols from the orthogonal subcarriers is accomplished using a Fast Fourier Transform (FFT) operation on a block of received samples. Thus, the IFFT and FFT blocks at the transmitter and the receiver, respectively, are important components in an OFDM system as shown in Figure 1.

A lot of work has gone into the optimization of the FFT implementations and the design community has leveraged this trend to advantage leading to popularity of OFDM based systems. The time-frequency view of an OFDM signal is shown in Figure 2, where the important parameters like subcarrier spacing and OFDM symbol period are shown. One can see from the figure that even though the subcarrier signals are overlapping in the time and frequency domains, there is no mutual interference when the sampling is done at certain specific points in the frequency domain called subcarrier positions. This is one of the most important properties of an OFDM signal and this leads to higher spectral efficiency as compared to frequency division multiplexed

(FDM) system. The granularities in the time and frequency domain are the OFDM symbol period (T_{os}) and the subcarrier spacing (Δf), respectively. In addition, a cyclic prefix (CP) is added to the OFDM symbol to protect against interference between OFDM symbols and against the loss of orthogonality due to multipath channel.

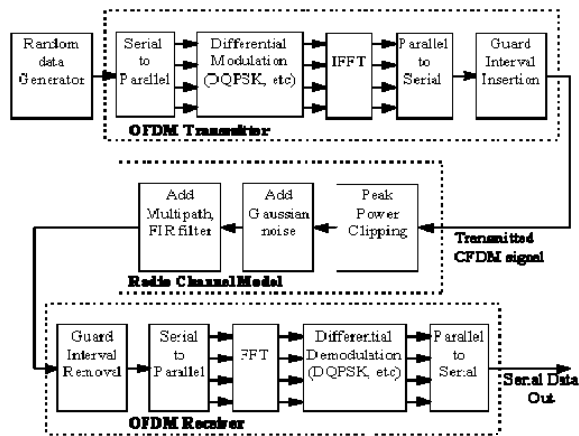

Figure 1: OFDM Transmitter and Receiver Architecture using IFFT and FFT-based Processings.

The choices of values for these parameters are based on channel conditions, efficiency requirements, hardware and algorithmic capabilities. For example, in a typical WLAN application where mobility is not an issue, the channel delay spread and the frequency offset are important factors in the design of OFDM parameters.

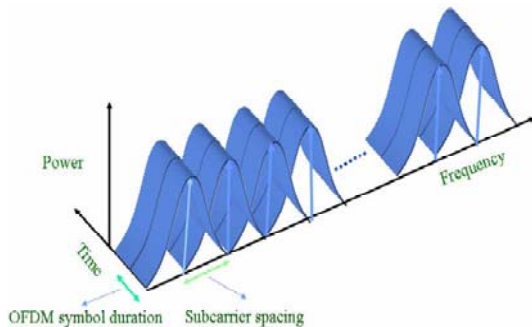

Figure 2: The Time-Frequency View of an OFDM Signal.

However, in mobile WiMAX systems, the Doppler spread also has to be considered along with the above mentioned parameters in the design. For Wi-Fi, the subcarrier spacing is about 300 KHz while in mobile WiMAX, the value is around 11 KHz. The cyclic prefix duration is about 800 nanoseconds for Wi-Fi and is typically about 10 microseconds for WiMAX.

Adaptive Modulation and Coding (AMC) on the different subcarriers is another feature in OFDM systems which has been successfully used in the discrete multitone standard [9] and has been proposed for use in WiMAX and in high speed extensions of Wi-Fi which is referred to as 802.11n [10]. The frequency domain variations of the multipath channel are used effectively with AMC so as to obtain advantages such as higher data rates and lesser transmitted power when compared with uniformly loaded system. In OFDM systems with AMC, the knowledge of the multipath channel's characteristics at the transmitter is obtained through the feedback mechanisms which are also being considered in Wi-Fi and WiMAX.

The ability to use multiple antennas to enhance data rates and reliability is expected to be an important feature in most high speed wireless systems. However, the use of this feature is much easier in OFDM as compared to their use in single carrier communication systems. The reason is due to the inherent multicarrier nature which transforms a broadband transmission in a multipath fading channel to several parallel narrowband transmissions. Thus, techniques and methods which have been extensively developed for narrowband or flat fading wireless channels can be reused in a broadband context. For instance many innovations in MIMO and space-time coding [6] which are likely to be a key feature in wireless systems can be easily extended when OFDM is used. Related signal processing tasks like channel estimation are much easier in OFDM systems as compared with their implementation in other transmission techniques.

OFDM BASED MULTIPLE ACCESS TECHNIQUES

Various multiple access schemes can be combined with OFDM transmission and they include: orthogonal frequency division multiplexing-time division multiple access (OFDM-TDMA), OFDMA, and multicarrier-code division

multiple access (MC-CDMA). In OFDM-TDMA, time slots in multiples of OFDM symbols are used to separate the transmissions of multiple users as shown in Figure 3. This means that all the used subcarriers are allotted to one of the users for a finite number of OFDM symbol periods. In WiMAX, one of the allowed transmission mode uses OFDM-TDMA wherein the base station allocates the time slots to the users for the downlink (DL) and the uplink (UL) transmissions. Note that even in the distributed access scheme in Wi-Fi, assuming that there are no collisions, a similar principle is followed. The only difference from OFDM-TDMA is that the users capture the channel and use it for certain duration, i.e., time dimension is used to separate the user signals [8].

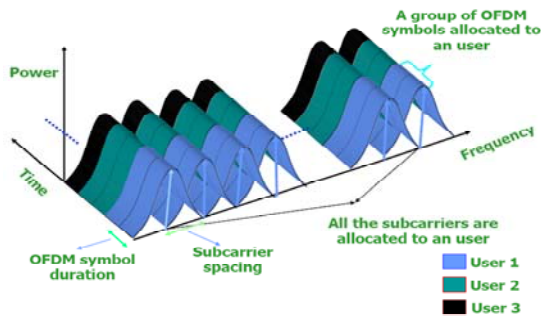

Figure 3: Time-Frequency of an OFDM-TDMA Signal.

In OFDMA systems both time and/or frequency resources are used to separate the multiple user signals. Groups of OFDM symbols and/or groups of subcarriers are the units used to separate the transmission to/from multiple users. In Figure 4, the time-frequency view of typical OFDMA signal is shown for a case where there are 3 users.

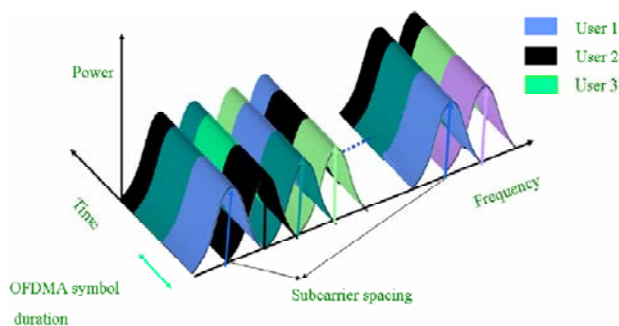

Figure 4: Time-Frequency View of an OFDMA Signal.

It can be seen from the figure that users' signals are separated either in the time-domain by different OFDM symbols and/or in the subcarrier domain. Thus, both the time and frequency resources are used to support multiuser transmissions.

In MC-CDMA systems a data symbol is sent on multiple subcarriers by using a spreading code, which is different from multiple access users [7]. Multiple user signals overlap in time and frequency domain but they can be separated at the receiver by using the knowledge of the spreading codes. Thus, MC-CDMA can be considered as a combination of OFDM and CDMA schemes resulting in benefits due to both of these approaches. Other variants of MC-CDMA systems have also been discussed in [11].

ORTHOGONAL FREQUENCY DIVISION MULTIPLE ACCESS

In OFDMA systems, the multiple user signals are separated in the time and/or frequency domains. Typically, a burst in an OFDMA system will consist of several OFDM symbols. The subcarriers and the OFDM symbol period are the finest allocation units in the frequency and time domain, respectively. Hence, multiple users are allocated different slots in the time and frequency domain (i.e., different groups of subcarriers and/or OFDM symbols are used for transmitting the signals to/from multiple users). For instance, Figure 5 illustrates an example where the subcarriers in an OFDM symbol are represented by arrows and the lines shown at different times represent the different OFDM symbols.

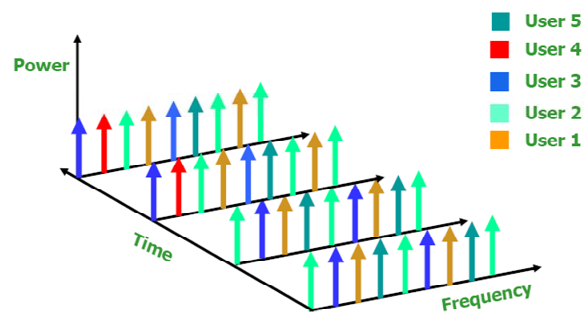

Figure 5: Allocation of Resources to Users in OFDMA.

We considered here 5 users and have shown in the figure how the resources can be allocated by using the different subcarriers and OFDM symbols.

Sub-channels in OFDMA

In practice, the allocation in the frequency domain is not addressed at the level of subcarriers. Typically, sub-channels which are the smallest granular units in the allocation are created by grouping subcarriers in an OFDM symbol in various ways. The formation of these sub-channels from carriers is an important concept in OFDMA systems. The formation can be classified into 2 types; one is the mapping of a contiguous group of subcarriers into a sub-channel called *Adjacent Subcarrier Method (ASM)* and the other is the diversity/permutation based grouping called *Diversity Subcarrier Method (DSM)*.

Adjacent sub-carrier method (ASM) in OFDMA

In DSM, the sub-channel typically contains non-contiguous subcarriers. An example of the allocation using the two methods is illustrated in Figures 6a and 6b, respectively. In the ASM method, a sub-channel typically contains a group of contiguous subcarriers and it's expected that the channel frequency responses on the subcarriers in a sub-channel will be strongly correlated. This is based on the fact that subcarriers which fall within the coherence bandwidth have similar responses. The ASM is suitable for the use of adaptive modulation and coding (AMC), as a strongly correlated block of subcarriers can be considered to be together as a unit to enable simple channel feedback which is necessary to implement the bit-loading. Note that if the subscriber responses were uncorrelated, then the channel responses on each subcarrier will have to be fed back to the transmitter resulting in a higher overhead. Thus, the channel feedback which consumes valuable bandwidth and power can be simplified when AMC is used along with ASM. Moreover, simplification to the adaptive loading algorithm used in AMC can be achieved when the adjacent subcarrier have similar responses [12]. A frequency selective fading channel has inherent frequency diversity (FD) due to the variation of the channel response in the frequency domain (i.e., the subscriber from different frequency position in the frequency domain are likely to experience different channel

fading conditions). This FD has been leveraged in Wi-Fi systems by using suitable error control coding and interleaving.

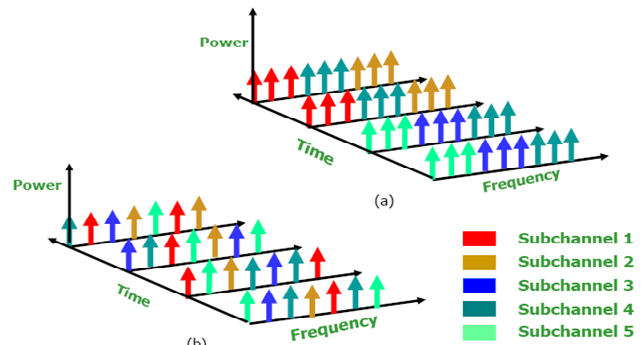

Figure 6: Sub-Channelization Examples: (a) ASM Method, (b) DSM Method.

Diversity sub-carrier method (DSM) in OFDMA

In the DSM, subcarriers from seemingly random position in the frequency domain are grouped into a sub-channel. Thus, a channel has potential frequency diversity which can be leveraged when the data to be sent on this sub-channel is suitably coded and interleaved. Such bit interleaved coded modulation (BICM) methods have been used in Wi-Fi and are also being used in WiMAX systems. Frequency hopping methods can also be combined with the DSM method such that the subcarriers in a particular sub-channel are not constant in time. The time granularity for ASM and DSM is in multiples of OFDM symbols. For example, the same sub-channel in two OFDM symbols could be the basic allocation unit. Users are typically allotted one or more channels for one or more OFDM symbols depending on the allocation and the requirements. Note that sub-channelization allows us to handle resources as groups of subcarriers and OFDM symbols. In the following section, by considering the WiMAX system, we give some practical examples to gain more insight into understanding the advantages.

SUB-CHANNELIZATION IN WiMAX

In WiMAX, both the ASM and DSM based sub-channelization have been defined with the latter being mandatory. We first discuss the mandatory

DSM method and explore an example of a sub-channel formation in the WiMAX system. In WiMAX, the number of subcarriers is not fixed and we consider a system with a maximum of 2048 subcarriers which is typically used with a 20 MHz deployment. Only 1680 subcarriers are used and the edge subcarriers are unused as shown in Figure 7. In addition, certain subscribers are earmarked for sending known symbols and are called pilot subcarriers. These subscribers can be used for tracking the various effects caused by the channel and hardware. We consider the downlink as an example case to highlight the various points in the mandatory DSM which is called the Partial Usage of Subcarriers (PUSC) method.

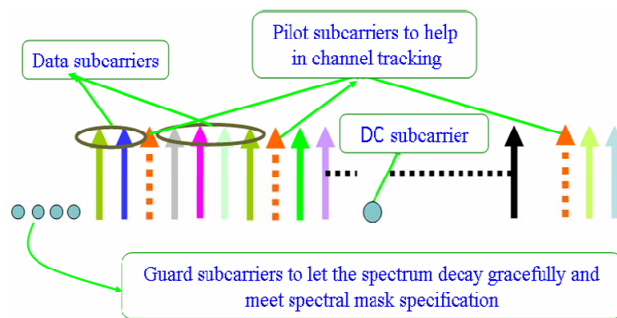

Figure 7: Typical Sub-Carrier View of an OFDMA Symbol in WiMAX.

The DL PUSC allocation method specified in WiMAX groups 24 randomly positioned subcarriers (defined in the standard) into a sub-channel which enables leveraging of the frequency diversity. The same sub-channel is allocated in 2 consecutive symbols thus making 48 subcarriers as the basic resource unit in this method. Hence, the user data is partitioned into 48 symbols for fitting this slot mentioned in WiMAX. The details of the sub-channelization are specified clearly so that all users know the specific subcarriers that are grouped in a specific sub-channel. Note that the granularity of about 24 subcarriers in an OFDM symbol allows us to flexibly allocated resources for different services. A voice call might need only a single sub-channel in every OFDM symbol while a video application might need a large number of sub-channels. This sub-channelization allows us to address the requirements of different types of services while leveraging frequency diversity.

Adjacent and Diversity Sub-carrier (ASM & DSM) Methods in WiMAX

The ASM is optional in WiMAX and different ways of forming a sub-channel are specified. Instead of rearranging the physical clusters into logical clusters, two consecutive physical clusters can be grouped to form a sub-channel. Channel knowledge is essential at the transmitter and a feedback mechanism is specified in WiMAX. For instance, special slots are allocated in the uplink part of the frame for the users to feedback the channel information. The channel information typically contains the signal-to-interference-noise-ratio (SINR) values as measured by the mobile in certain frequency bands which is used by the BS to perform AMC on different associated sub-channels. Channel feedback can also be used in the DSM operation (i.e., it roughly indicates the distance of the mobile from the BS).

Suitable modulation and coding can be chosen for all the subcarriers used for that particular user by using this information so as to achieve higher throughputs. Such a method is also used in other systems which are being proposed as enhancements to the 3G standards. The uniqueness of OFDMA systems is that the modulation and coding can be chosen at a sub-channel level rather than for the entire frequency region over which the signal is sent resulting in gains which is not available in CDMA based 3G standards. The challenge lies in leveraging it potential by intelligent scheduling of traffic to users based on channel information, mobility and QoS requirements as discussed in [14]. A BS can use different sub-channelization methods in a frame by informing the associated mobiles about the sub-channelization procedure followed in a particular duration. For example, a typical frame starts by using sub-channels formed using DBM, however, in the latter part of the frame, ASM and other optional sub-channelization methods can be used after proper signalling information is broadcast to the associated users.

In WiMAX deployment around the globe, the bandwidth operation can vary from 1.25MHz to 20MHz depending on the spectrum allocation in different countries. This means that the OFDM parameter like the subcarriers spacing and the OFDM symbol period can vary between deployments if the same number of subcarriers is used. Hence, the hardware and algorithm designed for WiMAX are made flexible for the same equipment planned to be used in different

bandwidths. One of the problems of operating with different subcarriers spacing is that the effects due to Doppler spread and frequency offsets changes with different subcarrier spacing [14]. Hence, the baseband algorithms that are used to compensate for these effects need to be tuned specifically for different bandwidths used. This is not a desirable situation in terms of hardware/algorithm. Consequently, to overcome this problem, the scalable OFDMA (SOFDMA) approach was proposed wherein the total number of subcarrier was scaled according to the bandwidth of deployment [15]. In WiMAX, the number of sub-carriers range from 128 to 2048 depending on the bandwidth leading to the same subcarrier spacing of around 11 KHz.

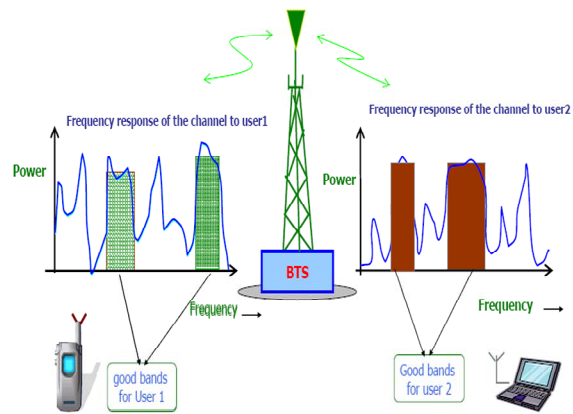

Figure 8: Illustration of Multiuser Diversity.

MULTIUSER DIVERSITY USING OFDMA

One of the advantages of OFDMA over CDMA is the ability to perform scheduling using both the time and frequency responses of the channel. For instance, consider the frequency responses of two users at different locations in a cell as shown in Figure 8. Note that there are good and bad frequency bands of the two users which may be different depending on their location. This diversity across the channels for different users is called multiuser diversity [16] which can be used advantageously by allocating sub-channels that fall into good portion for the 2 corresponding users leading to advantages like higher rate support. Such an approach is suitable when combined with ASM based sub-channelization, as the channel response on contiguous subcarriers is highly correlated leading to easier identification and allocation of good and bad bands for a user. In extensions to 3G cellular systems like HSDPA and EVDO, only time based scheduling is used whereas in OFDMA based systems, the ability to use the frequency responses make it more appealing for the next generation cellular services which are striving to support higher bit-rates.

COMPARISON ANALYSIS

We compare in Table 1 the Adjacent Subcarrier Method (ASM) and Diversity Subcarrier Method (DSM)-based sub-channelization techniques described earlier. This is followed by the comparison of OFDMA and OFDM-TDMA techniques in Table 2 to summarize the various concepts studied and worked on in this paper.

Table 1: Comparison of ASM and DSM in OFDMA

Concepts	ASM	DSM
Gain / Benefits	Loading gain	Diversity gain
Interference	No interference diversity/averaging	Interference diversity/averaging
Reuse	One (1) frequency reuse not possible	One (1) frequency reuse possible
Mobility Support	Good for fixed deployments	Can work in fixed and mobile deployments
Multiuser Diversity	Can help leverage multiuser diversity in the frequency domain	Cannot use multiuser diversity in the frequency domain
Channel Information	Necessary	Not needed
Scheduling at BS	Complex scheduler needed to leverage benefits	Simple scheduler is sufficient
Deployment in WiMAX	Likely to happen in future combined with beamforming	Likely to be deployed in the near future and later combined with MIMO techniques

Table 2: Comparison of OFDM-TDMA and FDMA.

Concepts	OFDM-TDMA	OFDMA
Frequency reuse	One (1) frequency reuse not possible	One (1) frequency reuse possible
Interference diversity	No interference diversity/averaging effect	Can use interference diversity and averaging
Support for different services	Only 1 user can be served in an OFDM symbol leading to poor granularity in the frequency domain	Can serve multiple users/services in an OFDM symbol due to better granularity in the frequency domain. Voice and video applications with different rate and delay requirements from different users can be served simultaneously.
Support for multiuser diversity	Cannot support multiuser diversity as all subcarriers are allotted to a single user at any given time.	Can leverage multiuser diversity using the ASM allocation.

7. van Nee, R.D.J. and R. Prasad. 2000. *OFDM for Wireless Multimedia Comms*. MA, Artech House, New York, NY.
8. Gast, MS. 2005. "802.11 *Wireless Networks*. O'Reilly Publications: Chicago, IL.
9. Coiffi, J. et al. 1998. *Understanding Digital Subscriber Line Technology*. Prentice Hall: Englewood, NJ.
10. <http://www.enhancedwirelessconsortium.org/ho>
11. Hanzo, L. et al. 2003. *OFDM and MC-CDMA for Broadcast Multi-User Communication, WLANs and Broadcasting*. Wiley and Sons: New York, NY.
12. Chung, S.T. and A. Goldsmith. 2001. "Degree of Freedom in Adaptive Modulation: A Unified view," *IEEE Trans. Comms.* 49(9): 1561-1571, Sept. 2001.
13. <http://standards.ieee.org/reading/lanman/restricted/802.16e-2005.pdf>
14. Taesoo Kwon, Howon Lee, Sik Choi, Juyep Kim, Dong-Ho Cho, Sunghyun Cho, Sangboh Yun, Won-Hyoung Park, and Kiho Kim 2005. "Design and Implementation of a Simulator Based on a Cross-Layer Protocol between MAC and PHY layers in a WiBro Compatible IEEE 802.16e OFDMA system". *IEEE Communications Magazine.* 43(12), Dec. 2005.
15. Yadhoobi, H. 2004. "Scalable OFDMA Physical Layer in IEEE 802.16 WirelessMAN". *Intel Technology Journal.* 8(3): 201-212, Aug. 2004.

REFERENCES

1. Laroia, R. and J. Li. 2004. "Designing a Mobile Wireless Access Network". *IEEE Signal Processing Magazine.* 25:20-28, Sept. 2004.
2. Lee, S. et. al. 2006. "The Wireless Broadband (WiBro) System for Broadband Wireless Internet Services". *IEEE Communication Magazine.* 45: 106-112, July 2006.
3. www.wimaxforum.org
4. <http://grouper.ieee.org/groups/802/20/index1.html>
5. Ekstrom, H. et. al. 2006. "Technical Solution for the 3G Long-Term Evolution". *IEEE Communication Magazine.* 44(3), March 2006.
6. Tse, D. and P. Viswanath. 2005. *Fundamentals of Wireless Communication*. Cambridge Press: Boston, MA.

ABOUT THE AUTHOR

Frank A. Ibikunle, received his B.Sc. degree in Electrical/Electronics Engineering from University of Science and Technology, Port-Harcourt, Rivers-State, Nigeria in 1986. In 1993, he won a Federal Government Scholarship award to study abroad and came back with a Doctorate in Telecommunications Engineering (research work) in 1997 from the University of Posts and Telecommunications, Beijing, China. He had 18 years of practical working experience with the largest telecommunications carrier company in Nigeria (called NITEL) and the mobile arm of the company (M-TEL) before joining academia. He is presently at Covenant University, Electrical and Information Department of the College of Science and Technology, Ota, Nigeria. His present areas of research are in Next Generation Networks/Convergence, Artificial Neural Networks for signal processing, and Broadband Wireless

Access Technologies. He has great number of publications in both national and international journals and conference proceedings. He is a member of the following professional bodies: Nigerian Society of Engineers, IEEE, and Nigerian Institute of Management.

SUGGESTED CITATION

Ibikunle, F.A. 2009. "Broadband Wireless Access Solution based on OFDMA Technique in WiMAX IEEE 802.16". *Pacific Journal of Science and Technology*. 10(1):286-294.

 [Pacific Journal of Science and Technology](http://www.akamaiuniversity.us/PJST.htm)